



USER MANUAL

AUBO – i16 & CB - M

Please read this manual carefully before using the product.





遨博（北京）智能科技股份有限公司
AUBO (BEIJING) ROBOTICS TECHNOLOGY CO., LTD

User Manual

AUBO – i16 & CB-M

Version 4.5.13

This manual is applicable to AUBOPE V 4.5. For details, please refer to the version information section of this manual. Please check the actual product version information carefully before use to ensure consistency.

The user manual will be checked and revised periodically, and the updated content will appear on the latest version.

The information in this manual is subject to change without notice and should not be regarded as a commitment by AUBO (Beijing) Robotics Technology Co., Ltd.

AUBO (Beijing) Robotics Technology Co., Ltd. assumes no responsibility for any errors or omissions in this document. AUBO (Beijing) Robotics Technology Co., Ltd. assumes no responsibility for incidental or consequential damages arising from use of this manual and products described herein.

Please read this manual before install or use.

Please keep this manual to read and as reference any time.

The pictures in this manual are for reference only, please refer to the actual product received.

Copyright © 2015-2023 AUBO All rights reserved

Catalog

Catalog	i
Preface	vii
Product Components.....	viii
More Information.....	viii
1. Safety	1
1.1 Introduction.....	1
1.2 Warning Symbols	1
1.3 Safety Precautions.....	3
1.3.1 General	3
1.3.2 Terms and Conditions.....	3
1.3.3 Operator Safety	6
1.4 Responsibility and Standard	7
1.5 Hazard Identification	9
1.6 Intended Use	10
1.7 Emergency Situations	11
1.7.1 Emergency Stop Device	11
1.7.2 Recovering from the Emergency Condition	12
1.7.3 Emergency Move for Joint.....	12
1.7.4 Excessive Force Protection	12
1.7.5 Collision protection	13
2. Transportation and Precautions	15
3. Maintenance, Repair and Disposal	17
3.1 Maintenance and Repair.....	17
3.2 Disposal.....	18
4. Warranties.....	19
4.1 Product Warranty	19
4.2 Disclaimer.....	19
4.3 Consumable list.....	21

5.	Robot Hardware Composition	23
6.	Robot Installation	25
6.1	Brief Installation Steps	25
6.2	Important Safety Instructions	25
6.3	Workspace of the Robot	26
6.3.1	Mechanical Dimensions of Manipulator	26
6.3.2	Effective Working Range	27
6.4	Hardware Installation	28
6.4.1	Manipulator Base	28
6.4.2	Manipulator Installation	29
6.5	End-effector Flange	31
6.6	Cable Connection	32
6.6.1	Teach Pendant Cable Connection	32
6.6.2	Manipulator Cable Connection	32
6.6.3	Power Cable Connection	34
7.	Control Box	35
7.1	Introduction	35
7.2	Electrical Warnings and Cautions	36
7.3	Control Box Panel Introduction	37
7.3.1	Front Panel	37
7.3.2	Side Panel	38
7.3.3	Upper Panel	38
7.4	Selection of Working Mode	40
7.4.1	Manual Mode	40
7.4.2	Linkage Mode	41
7.5	Teach Pendant Enable/Disable Button	49
8.	Electrical Interface	51
8.1	Electrical Warnings and Cautions	51
8.2	Control Box Communication Interface	52
8.3	Control Box I/O Power Supply	53
8.3.1	Internal Power Supply	53
8.3.2	External Power Supply	53

8.4 Safety I/O.....	54
8.4.1 Introduction	54
8.4.2 Safety Tips	54
8.4.3 Safety I / O Function Definition.....	54
8.4.4 Default Safety Configuration	56
8.4.5 External Emergency Stop Input.....	57
8.4.6 Safeguard Stop Input	57
8.4.7 Reduced Mode Input	59
8.4.8 Safeguard stop Resert Input	60
8.4.9 Three-Position Enabling Device Input	61
8.4.10 Operational Mode Input.....	62
8.4.11 Force Control Enable Input	62
8.4.12 System Stop Input	63
8.4.13 Robot Emergency Stop Output (NO)	64
8.4.14 Robot Moving Output	65
8.4.15 Robot Not Stopping Output.....	66
8.4.16 Reduced Mode Output.....	67
8.4.17 Non-Reduced Mode Output.....	68
8.4.18 System Error Output.....	69
8.4.19 Robot Emergency Stop (NC)	70
8.4.20 AUBOPE Operation Indication Output.....	70
8.5 Internal I/O	71
8.6 General I/O.....	71
8.6.1 General Purpose Digital I/O Interface	72
8.6.2 Analog I/O Interface	75
8.6.3 Clear Alarm Signal Interface	77
8.7 Remote Switch Control I/O Interface.....	77
8.7.1 Remote Power On	78
8.7.2 Remote Power Off	78
8.8 Linkage Control I/O Interface	78
8.9 Robot Tool I/O Interface	79
9. Getting Started	83
9.1 Basic Function Introduction	83
9.2 Robot System Installation	84

9.3 Power on the Robot System	84
9.3.1 Preparation before Power up.....	84
9.3.2 Power on the Robot System.....	85
9.4 Power Off the Robot System	86
9.5 Start System Quick	87
10. Teach Pendant	89
10.1 Introduction	89
10.2 AUBOPE Software Operation Interface	89
10.2.1 User Login.....	91
10.2.2 Initialization Window	92
10.2.3 Robot Movement Control	93
10.3 Robot I/O Settings and State Display	103
10.3.1 Controller I/O Panel.....	103
10.3.2 User I/O Panel	104
10.3.3 Tool I/O Panel.....	105
10.4 Settings Interface	106
10.4.1 Pose Setting	106
10.4.2 Tool Calibration	107
10.4.3 Coordinate System Calibration.....	115
10.5 Robot Safety Settings.....	119
10.5.1 Basic Settings	119
10.5.2 Reduced Mode	121
10.5.3 Joint Limit	121
10.6 System Setting Interface	122
10.6.1 Language Setting	122
10.6.2 Date & Time Setting.....	122
10.6.3 Network Setting	123
10.6.4 Password Setting.....	123
10.6.5 Other Settings.....	124
10.6.6 Update	124
10.7 Extensions	128
10.8 System Info	129
10.9 About	130

11. Online Programming.....	131
11.1 Instruction	131
11.2 Text Box Editor	133
11.3 Project Tab.....	134
11.3.1 New Project	134
11.3.2 Load Project	135
11.3.3 Save Project	136
11.3.4 Default Project.....	137
11.3.5 Move Robot	138
11.3.6 Project Root Condition.....	140
11.4 Procedure (process).....	141
11.4.1 Calling Subproject Commands (Procedure)	142
11.4.2 Command Group.....	143
11.5 Move Condition	145
11.5.1 Type of Move	146
11.5.2 Arrival Ahead	154
11.5.3 Waypoint.....	165
11.6 Basic Command & Condition Tabs	167
11.6.1 Loop	167
11.6.2 Break	168
11.6.3 Continue.....	168
11.6.4 If..else	169
11.6.5 Switch...Case...Default.....	170
11.6.6 Set.....	171
11.6.7 Wait	172
11.6.8 Line Comment	172
11.6.9 Block Comment.....	173
11.6.10 Goto.....	173
11.6.11 Message	175
11.6.12 Empty	175
11.7 Advanced Command & Condition Tabs	176
11.7.1 Thread	176
11.7.2 Script	177
11.7.3 Offline Record	179

11.8 Record Track 180

11.9 Variable Tab 182

11.10 Timer..... 183

 11.10.1 Inserch Timer 183

 11.10.2 Timer State Display 184

11.11 Simulation Model 185

11.12 Project Log..... 186

11.13 Scripts File Configuration..... 186

AppendixI

 A. GlossaryI

 B. CERTIFICATION II

 C. Guideline III

 D. Technical Specification.....IV

 E. PayloadVI

 F. Alarm Information & Description of General Problem VII

Preface

Thank you for purchasing this lightweight modular industrial robot with 6 degrees of freedom, AUBO-i16, which is researched and developed by AUBO (Beijing) Robotics Technology Co., Ltd.



AUBO-i16 Manipulator

AUBO series robot adopts the fully modular design and uses system towards developers. Users can develop their own robot control system based on the application interface provide by the AUBO platform. Meanwhile, AUBO robot is equipped with a dedicated programmable operation interface, which allows the user to observe robot's operating status in real time, carry out many control settings for robots, and perform offline simulation. This can improve the efficiency of practical application greatly.

AUBO-i16, the second generation of intelligent lightweight 6 DOF modular robot, whose payload is 16kg, is one of AUBO series modular robots.

Product Components

The components of the AUBO-i16 robot are listed as below.

Table 1 AUBO-i16 robot components list

Name	Quantity
AUBO-i16 Manipulator	1
Teach Pendant	1
Control Box	1
Teach Pendant Cable	1
Manipulator Cable	1
Power Cable	1
Manipulator Base (optional)	1

More Information

If you need more information, please visit our official website at: www.aubo-robotics.cn



1. Safety



1.1 Introduction

This chapter introduces the principles and norms that should be followed when operating a robot or robot systems. Integrators and users must read the relevant description in this manual carefully and fully understand and strictly adhere to the warning symbols in the contents. Because of the complexity and highly risks of the robot system, operators need to be fully aware of the operation risks and follow the requirements and specifications in this manual. Both the integrators and users should have adequate safety awareness and follow the Industrial robots' safety regulations, ISO 10218.

1.2 Warning Symbols

The table below defines the captions specifying the danger levels used throughout this manual. These warnings, which are relevant to safety, must be observed.

Symbol	Description
	<p>This indicates an imminently hazardous electrical situation which, if not avoided, could result in death or serious injury.</p>
	<p>This indicates a potentially hazardous hot surface which, if touched, could result in injury.</p>
	<p>This indicates an imminently hazardous situation which, if not avoided, could result in injury or major damage to the equipment.</p>

Symbol	Description
	<p>This indicates a potentially hazardous electrical situation which, if not avoided, could result in injury or major damage to the equipment.</p>
	<p>This indicates a potentially situation which, if not avoided, could result in injury or major damage to the equipment. Marked with this symbol, depending on the circumstances, sometimes may have significant consequences.</p>
	<p>This indicates a situation which, if not avoided, could result in injury or major damage to the equipment. Marked with this symbol, depending on the circumstances, sometimes may have significant consequences.</p>

1.3 Safety Precautions

1.3.1 General

This manual includes safety precautions for protecting the user and preventing damage to the machine. Users need to learn all the relevant descriptions and fully understand the safety precautions. In this manual, we try to describe all the various situation as much as possible. However, we cannot describe all the matters, which must not be done or which cannot be done, because there are so many possibilities.

1.3.2 Terms and Conditions

The following basic information needs to be understood and followed when using the robot or robot system for the first time. Also, other safety-related information will be introduced in other parts of this manual. However, it may not cover everything. In practical applications, it is necessary to analyze specific issues.



1. Make sure to install the robot and all electrical equipment according to the manual requirements and specifications.
2. Make sure to conduct a preliminary test and have inspection for robots and its protection systems before using the robot or putting it into production for the first time.
3. Make sure to check the system and equipment for completion, operational safety, and any damage that can be detected before starting the system and equipment for the first time. The test needs to confirm whether it accords with valid safety production rules and regulations in country or region. All safety functions must be tested.
4. Make sure that all safety parameters and user programs are correct, and all safety functions are working normally. A qualified robotics operator is needed to check each safety function. Only pass the thorough, careful safety test and reach the safe level, we can power on the robot.
5. Installation and commissioning need to be performed by professionals in accordance with the installation standards.
6. When the robot is installed, a comprehensive risk assessment is necessary, and the test results need to be recorded in a report.
7. Set and modify the safety parameters by a qualified person. Use password or isolation measures to prevent unauthorized people from setting and modifying safety parameters. After a safety parameter is modified, the related safety functions need to be analyzed.

8. When the robot is in an accident or abnormal operation, the emergency stop switch needs to be pressed down to stop the movement.

9. AUBO-i16 joint module has brakes inside, it will remain manipulator's pose when power outage occurred. Don't power on and power off frequently. It is recommended that the time interval of each switch should be more than 10s.

10. AUBO-i16 has collision detecting function. When the external force of the manipulator is beyond the users' safety range, the manipulator will automatically stop to prevent the robot or operator from damage or injury. This function is a particularly for the safety work, but robot system must be in the normal operating range and use the AUBO series control box. If the user develops the controller personally, the robot will not have the functions above, and all the dangerous consequences are undertaken by its owner.

1. Make sure that the robot's joints and tools are installed properly and safely.

2. Make sure that there is enough space for the manipulator to move freely.

3. Don't use robot if the robot is damaged.

4. Do not connect any safety equipment to normal I/O. Use safety-related interfaces only.

5. Make sure to use the correct installation settings (e.g., the robot's mounting angle, TCP weight, TCP offset, security configuration). Save and load the installations file along with the program.



6. Tools and barriers should not have sharp edges or pinch points. Make sure that all people keep their heads and faces outside the reach of the robot.

7. Be aware of robot's movement when using the teach pendant.

8. Any strike would release a large amount of kinetic energy, which is much higher than the case of high speed and high payload.

9. The different mechanical linking may increase the risk or lead to new dangers. Make sure to perform a comprehensive risk assessment for entire installation. Always choose the highest-level performance when different safety and emergency shutdown performance level is needed. Make sure to read and understand all the devices' manual used for installation.

10. Do not modify the robot. Changes to the robot may cause unpredictable danger to the integrator. The robots authorize restructuring need in accordance with the latest version of all relevant service manuals. If the robot is changed or altered in any way, AUBO (Beijing) Robotics Technology Co., Ltd disclaims all liability.

11. User needs to check the insulation and protection measures before transportation.

12. Transporting robots must follow the transport requirements. Handling carefully and avoid t bumps.



1. The robot and control box generate heat during operation. Do not handle or touch the robot while the robot is working or just stop working.

2. To cool the robot down, power off the robot and wait for one hour.

3. Never stick fingers behind the internal cover of the control box.



1. When the robot is combined with or working with machines capable of damaging the robot, then it is highly recommended to test all the functions of the robot and the robot program separately. It is recommended to test the robot program using temporary waypoints outside the workspace of other machines.

2. AUBO (Beijing) Robotics Technology Co., Ltd cannot be held responsible for any damages caused to the robot or to other equipment due to programming errors or malfunctioning of the robot.

3. Don't expose the robot to a permanent magnetic field. Very strong magnetic fields can damage the robot.

1.3.3 Operator Safety

In the operation of the robot system, we must ensure the safety of the operators first. The general precautions are listed in the table below. Please take appropriate measures to ensure the safety of operators.



1. Each operator who uses the robotic system should be trained through a training course hosted by AUBO (Beijing) Robotics Technology Co., Ltd. Users need to make sure to fully grasp the safe and standardized operating procedures with the robot operating qualifications. Please inquire for training details, email: support@aubo-robotcs.cn
2. Do not wear loose clothing or jewelry when working with the robot. Make sure long hair is tied back when working with the robot.
3. When the device is running, even if the robot seems to stop, it is possible that robot is waiting for the signal and in the upcoming action status. Even in such state, it should be considered as the robot is in action.
4. A line should be drawing to mark the range of motion of the robot to let the operator knows the robot's, including the holding tools, (like mechanical hand or tools) operating range.
5. Make sure to set security-building measures (for example, rails, ropes, or protective screen) near the robot operating area to protect the operator and surrounding crowd. The lock should be set as needed so that those who are not operators cannot access the robot power supply.
6. When using the operation panel or the teach pendant, make sure to take off the gloves in case of operational errors.
7. Pushing or pulling the robot arm (at least 700N), force the joint to move in the emergency or abnormal condition (like a person is caught in or surrounded by a robot). Manually move the robot arm without electric drive only for emergency, and it may damage the joints.

1.4 Responsibility and Standard

AUBO - i16 can be combined with other equipment to form a complete machine, and itself is not complete. The information in this manual does not cover how to design, install, and operate a complete robot, nor does it cover all peripheral equipment that can influence the safety of the complete system. The safety of installing a complete robot is determined by how it integrated.

Integrators must follow the standards and regulations and laws of the country where the robot is installed to perform a risk assessment for its system design and installation. Risk assessment is one of the most important things that integrators must done. Guidance on the risk assessment process may be found in the following standards.

- ISO 12100:2010 Safety of machinery - General principles for design - Risk assessment and risk reduction.
- ISO 10218-2:2011 Robots and robotic devices - Safety requirements - Part 2: Industrial robot systems and integration.
- RIA TR R15.306-2014 Technical Report for Industrial Robots and Robot Systems - Safety Requirements, Task-based Risk Assessment Methodology.
- ANSI B11.0-2010 Safety of Machinery; General Requirements & Risk Assessment.

AUBO robot integrators need to fulfill but not limited to the following responsibilities:

- Comprehensive risk assessment of complete robot system;
- Make sure the whole system design and installation is correct;
- Provide training to users and personnel;
- Create operational specifications for a complete system, specify instructions for process;
- Establish appropriate safety measures;
- Use appropriate methods to eliminate or minimize all hazards to acceptable level in the final installation;
- Convey the residual risk to the users;
- Mark the logo and contact information of the integrators on the robot;
- Archive technical file

Guidance on how to find and read applicable standards and laws is provided on: www.aubo-robotics.cn

All safety information contained in this manual are not considered as a guarantee for AUBO (Beijing) Robotics Technology Co., Ltd. Even if all the safety instructions are observed, the personnel injury or equipment damage caused by the operator is still likely to occur.

AUBO (Beijing) Robotics Technology Co., Ltd is committed to continuously improve the reliability and performance of the product. Therefore, we reserve the right to upgrade products without notice. AUBO (Beijing) Robotics Technology Co., Ltd seeks to ensure the accuracy and reliability of the contents in this manual but is not responsible for any errors or omissions.

1.5 Hazard Identification

Risk assessment should consider all potential contacts and foreseeable misuse between robot and operator. Operator's neck, face and head should not be exposed in case of collision. Without using peripheral safety devices, the robot needs to perform a risk assessment first to determine whether the risk is unacceptable, such as:

- The risk of using a sharp end-effector or tool connector.
- The risk of processing toxic or other hazardous substances.
- Fingers being caught by robot base or joint.
- The risk of being hit by manipulator.
- The danger due to incompletely fix of manipulator or connected tool.
- Danger due to impact between a heavy payload and a solid surface.

Integrators must measure these dangers and its associated risk level through a risk assessment. Identify and implement appropriate measures to reduce the risk to acceptable level. However, Integrators should be aware that specific robotic equipment may have other dangers.

Combine the inherent safety design which applied by AUBO robot with the safety specifications or risk assessment performed by integrators and users, risks that are associated with AUBO-i16 operation should be lower to reasonable and practicable level. Any residual risks before installing will be conveyed to integrators and users through this manual. If integrator's risk assessment shows that there may have unacceptable risks in specific applications, integrators must take appropriate risk reduction measures to eliminate or minimize these risks to acceptable level. It is not safe to use before taking appropriate risk reduction measures (If necessary).

If perform noncooperative installation (for example, when using dangerous tools), risk assessment may infer that integrator need to connect additional security devices (such as a boot device) when it is programming to ensure the safety of personnel and equipment.

1.6 Intended Use

AUBO robot is industrial only and intended for operating or fixing tools or device or for processing or transferring components or products. AUBO robot can only be used under specified conditions. For details about the operating environment and conditions, see appendix.

AUBO robot has a special level of safety operation. It can be used without setting peripheral safety device. However, it can only be used under non-hazardous circumstance which has passed the risk assessment. On the premise that not using any security device and sensing device, there will be no unacceptable risk when personnel or other objects in workplace (like tool, equipment, surfaces etc.) has expected or unexpected contact with AUBO robot or its end-effector.

Robot controllers and robots can only be used in general industrial equipment. Any use or application deviating from the intended use is deemed to be impermissible misuse. This includes, but is not limited to:

- Use in potentially flammable and explosive environments.
- Use to move or carry people or other animals.
- For devices such as medical devices that involve human life
- Use to have a major impact on social and public.
- Use under vibration environment like vehicle or ship.
- Use as a climbing tool.

1.7 Emergency Situations

1.7.1 Emergency Stop Device

Pressing the emergency stop button to immediately stop all robot's motion. Emergency stop shall not be used as a risk reduction measure, but as a secondary protective device. If multiple emergency stop buttons are connected, it should be recorded in the risk assessment of the robot application. Emergency stop buttons should comply with IEC 60947-5-5.

Emergency stop button can be found on the teach pendant, as shown in Figure 1-1, the button must be pressed when a dangerous situation or emergency occurs. Control box is equipped with an external port for emergency stop button. Integrators and users can use it according to the actual situation.

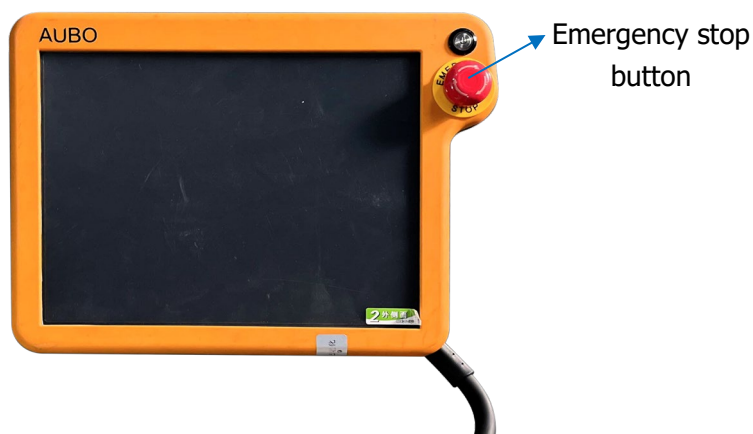

Figure 1-1 Emergency stop button



If the equipment or tools which connect to the end cause potential danger, it must integrate to the emergency stop circuit in system. It may result in death, serious injury or substantial property damage if failure to observe this warning notices.

1.7.2 Recovering from the Emergency Condition

All the button type emergency stop device has a "lock" function. This "lock" must be opened to end the emergency stop state.

Rotating emergency stop button can open the "lock".



Recovery from an emergency stop state is a simple but very important step. This step can only operate after making sure that the robot system is completely excluded from danger.

1.7.3 Emergency Move for Joint

In rare cases, it may be required to move one or more robot joints when the robot's power failure or in an emergency, which can force the robot to move by follow method:

Forced back-driving: Force a joint to move by pulling hard (at least 700 N) on the robot arm.



Forced to move the robot arm manually is limited to emergency situations and it may damage the joints.

1.7.4 Excessive Force Protection

Manipulator has excessive force protection. When manipulator is power-on and in stationary state, if impact force hit by operators or other objects mistakenly exceeds the safety threshold, manipulator will follow the direction of impact force to move passively. This function can reduce the damage when operators or other objects collide with manipulator.



This function can reduce the collision damage and required to perform risk assessment if other use is needed.

1.7.5 Collision protection

The Manipulator has collision protect function. During the operation of the manipulator, when the operator or other objects accidentally touch the manipulator and the collision force exceeds the safety range, the manipulator will enter **Type 2** stop state and enter the drag teaching mode. At this moment, the manipulator can be dragged to a relatively safe position and continue its operation by pressing buttons on the teach pendant. This function can ensure that when the operator or other objects collide with the manipulator, it reduces the damage to the person, to the objects and to the manipulator itself. At the same time, it saves the time of restarting the program and improves work efficiency. The safety range of the collision force can be changed by setting the collision level. For details, please refer to 10.5.1 Basic Configuration.

2. Transportation and Precautions

When hoisting robot, the moving parts should be located properly to avoid unexpected movement which can cause damage during hoisting and transportation. When packaging and transporting, it should follow packaging standards and mark with the required signs outside the package.

When transporting, the robot must remain in its transport position stably.

The control box should be lifted using handle.

When moving robot from packaging to installation position, hold the robot in place until all mounting bolts are safely tightened at the base of the robot.

Power up the robot after fixing it. Using hand-guiding to adjust robot orientation to a suitable location.

Save the original packaging after transportation. Store the packaging material in a dry place for future repackaging and moving the robot.

Users can move the manipulator to the installation position by using the package project in the **【Programming】** -> **【Project】** -> **【Load】** on the AUBOPE Programming Environment.



1. Make sure not to overload the robot's back or other body parts when the equipment is lifted.
2. All regional and national guidelines should be followed. AUBO (Beijing) Robotics Technology Co., Ltd is not responsible for any damage caused during the transportation of equipment.
3. Make sure to follow the instruction when installing a robot.

3. Maintenance, Repair and Disposal

3.1 Maintenance and Repair

Maintenance and repair work must strictly follow all safety instructions in this manual.

Maintenance, calibration and repair work must be performed in accordance with the latest versions of Service Manuals, which can be found on the support website: www.aubo-robotics.cn

All dealers in AUBO (Beijing) Robotics Technology Co., Ltd. should have the access to this website.

Maintenance must be performed by authorized integrators or AUBO (Beijing) Robotics Technology Co., Ltd. All parts returned to AUBO (Beijing) Robotics Technology Co., Ltd. will be returned according to the service manual.

Make sure to reach the safety level of maintenance and repair, follow all regional and national guidelines and test whether all safety functions work normally.

The purpose of maintenance and repair is to r to make sure that system runs normally or help it return to normal condition when system error occurs, including faults diagnosis and actual maintenance.

Operating manipulator or control box must follow safety procedures and warnings as below:



1. Remove the main input cable from the bottom of the control box to ensure that it is completely power off. Take necessary precautions to prevent other people from recharging the system during the repair period. After the power is turned off, the system must be re-examined to ensure that is powered off.
2. Please check the ground connection before turning the system back on.
3. Observe ESD (Electro-Static discharge) regulations when parts of the manipulator or control box are disassembled.
4. Avoid disassembling the power supplies inside the control box. High voltages can be present inside these power supplies for several hours after the control box has been switched off.
5. Prevent water and dust entering the manipulator or control box.



1. Replace the defective components by new components with the same article number or equivalent components approved by AUBO (Beijing) Robotics Technology Co., Ltd.
2. Reactivate any deactivated safety measures immediately after the work is completed.
3. Record all maintenance operations and save in technical documentation.
4. There is no self-serviceable part in control box. If maintaining or repairing service is required, please contact your dealer or AUBO (Beijing) Robotics Technology Co., Ltd.

3.2 Disposal

AUBO robot must be disposed in accordance with the applicable national laws, regulations and standards.

4. Warranties

4.1 Product Warranty

AUBO robots have the finite warranty period for **36 months**.

In the case of new devices and their components exhibiting defects resulting from manufacturing and/or material faults within **36 months** from shipment, AUBO (Beijing) Robotics Technology Co., Ltd. should provide the necessary reserve components to replace or repair the related components.

AUBO (Beijing) Robotics Technology Co., Ltd. has the ownership of the devices or components which have been replaced or returned to AUBO (Beijing) Robotics Technology Co., Ltd.

If the product is not under warranty, AUBO (Beijing) Robotics Technology Co., Ltd. reserves the right to charge the replacement or repair fee to the customer.

If there are any defects appear in the device outside the warranty period, AUBO (Beijing) Robotics Technology Co., Ltd. is not responsible for any damage or loss caused by the equipment, such as loss of production or damage to other production equipment.

4.2 Disclaimer

This Warranty will be invalid if the equipment defect is caused by improper handling or failure to follow the relevant information described in the user manual.

Failures caused by the following conditions are not covered by this warranty:

1. Products purchased through non-AUBO approved channels.
2. Does not meet the requirements of industrial standards or not following the user manual to install, connect wires and connect to other control devices.
3. Using products beyond the specifications or standards of the manual.
4. Using products beyond the appointed purposes.
5. The usage environment exceeds the nominal value of the product.
6. Used in grinding environments or special environments without product protection.
7. Product damage caused by improper transportation.
8. Damage caused by accident or crash.
9. Malfunctions or damages caused by modifications.
10. Not installing the original assembled components and accessories.
11. The damage caused by the third-party which is not AUBO (Beijing) Robotics Technology Co., Ltd. or the designated integrator while reconstructing, adjusting or repairing the original components.

12. Any nature disasters including fires, earthquakes, tsunamis, lightning, high winds and flooding.
13. Any malfunction not relates to AUBO (Beijing) Robotics Technology Co., Ltd.'s responsibility apart from the circumstances mentioned above.

Warranty will not be provided in following circumstances:

1. Unable to identify the product traceability number.
2. Unable to identify the production date or the warranty start date.
3. Changing the software or the internal data.
4. The malfunction cannot reappear or be identified by AUBO (Beijing) Robotics Technology Co., Ltd.
5. Using the products as radioactive equipment, biological test equipment or any other dangerous environment ascertained by AUBO (Beijing) Robotics Technology Co., Ltd.
6. Appearance parts and vulnerable parts.

According to the product warranty, AUBO (Beijing) Robotics Technology Co., Ltd. only provides warranty to the flaws and defects in the products and components which are sold to dealers.

AUBO (Beijing) Robotics Technology Co., Ltd. is not responsible for the relevant warranty responsibility to any other express or implied warranty or responsibility, including but not limited to the implied warranty to the merchantability or the specific use. In addition, AUBO (Beijing) Robotics Technology Co., Ltd. is not responsible for any indirect damage and consequences caused by the relevant products.

4.3 Consumable list

NO	Parts
1	Nameplate
2	Rubber Ring
3	Decorative Ring
4	Protection Cap of Tool End IO
5	Anchor Bolts of the Manipulator Base
6	Dust Cap on the Manipulator
7	Dust Cap on the Control Box
8	LCD Protective Film
9	Control Box Cover Board
10	Control Box Foot
11	Dust Cap on the Control Box Fan

5. Robot Hardware Composition



Figure 5-1 AUBO – i16 robot system

As shown in Figure 5-1, The AUBO - i16 robot system consist of a manipulator, a control box (which can choose a variety of models), a manipulator base and a teach pendant. The manipulator imitates human which has six joints and each joint represents a degree of freedom. As shown in Figure 5-2, manipulator's joint includes a robot base (joint 1), a shoulder (joint 2), an elbow (joint 3), a wrist1 (joint 4), a wrist2 (joint 5) and a wrist3 (joint 6). The manipulator base is used for the robot body and the base connection. End-effector is used to connect manipulator and tool. Aluminium pipe is used to connect shoulder and elbow or elbow and wrist. Through the AUBOPE user interface or hand-guiding, users can control the rotation of every joint and move end-effector to any poses.

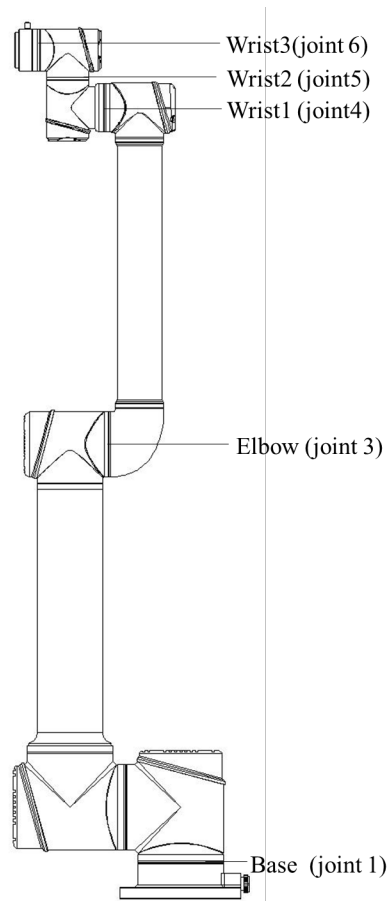

Figure 5-2 Manipulator Joints

The control box is the control body of the AUBO-i series of robots. The control box provides multiple IO interfaces and communicates with the robot body via the CAN bus.

There are 4 digital input and output interfaces and 2 analog input interfaces on the robot tool end. The teach pendant provides the user with a visual interface. The robot can be tested, programmed and simulated by the teach pendant, and the robot can be operated with a small amount of programming basis.





6. Robot Installation

6.1 Brief Installation Steps

The installation of AUBO robots includes:

1. Define a robot workspace.
2. Install the robot manipulator on base.
3. Install tools at the tool end.

6.2 Important Safety Instructions

	<p>Installation Conditions:</p> <ul style="list-style-type: none"> • No corrosive gases or liquids • No salt spray • No mechanical shock, vibration • No radioactive materials • No flammable materials • Ambient temperature:0°C ~ 45°C • Avoid direct sunlight (avoid using outdoor) • No oil mist • No dust or metal powders • No electromagnetic noise • Low humidity
	<p>Floor carrying capacity:</p> <p>Install manipulator on a hard surface which can undertake at least 10 times heavier than overturning moment of robot base and at least 5 times the weight of the manipulator. Moreover, the surface cannot be shaken. Please read appendix for more precise data of carrying capacity.</p>
	<p>Safety assessment is needed after every installation. Please strictly follow the instructions in chapter 1(Safety).</p>
	<p>Install additional equipment:</p> <p>If any additional modules, like cable, which are not provided by AUBO (Beijing) Robotics Technology Co., Ltd., are integrated in industrial robot, users have the responsibility to ensure these modules won't affect safety function.</p>



1. Safety assessment must be performed each time the robot is installed, and the instructions in Section 1 (Safety) are strictly observed.
2. The control box should be placed horizontally on the ground. A 50 mm gap should be reserved on each side of the control box to ensure smooth air circulation
3. The teach pendant can be hung from the control box. Make sure you don't step on the cable.



1. Make sure that the control box, teach pendant, and cable are not exposed to liquids. A wet control box can cause casualties.
2. The control box and teach pendant should not be exposed to dust or moisture in an IP54 class. Pay close attention to the environment where conductive dust is present.

6.3 Workspace of the Robot

6.3.1 Mechanical Dimensions of Manipulator

The mechanical dimensions of the manipulator are shown in Figure 6-1. The robot working range should be firstly considered during installation in case of bumping into people or equipment around.

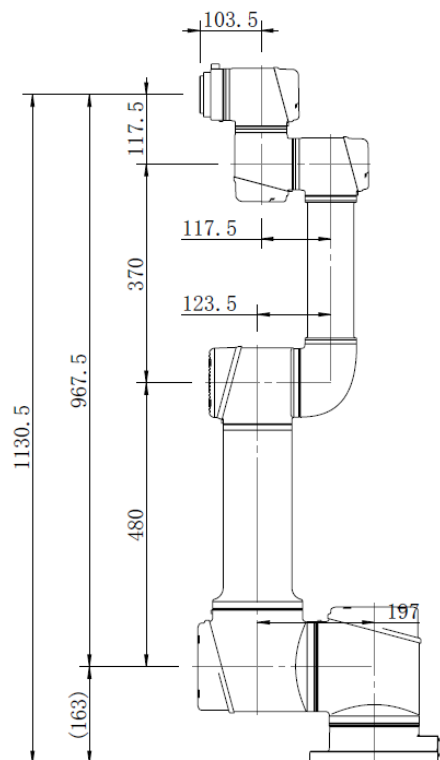

Figure 6-1 AUBO – i16 mechanical dimensions, unit: mm

6.3.2 Effective Working Range

The workspace of the manipulator, as shown in Figure 6-2, is a sphere of radius 967.5 mm except the cylindrical space directly above and directly below the robot base. When choosing the installation position, be sure to consider the cylindrical space directly above and directly below the robot base must avoid moving the tool into this cylindrical space as much as possible. In practical application, the range of rotation of joint 1/6 is $-360^{\circ} \sim +360^{\circ}$, joint 2/3/4/5 is $-175^{\circ} \sim +175^{\circ}$. The range of rotation of joint 4/5 is optional $-360^{\circ} \sim +360^{\circ}$.

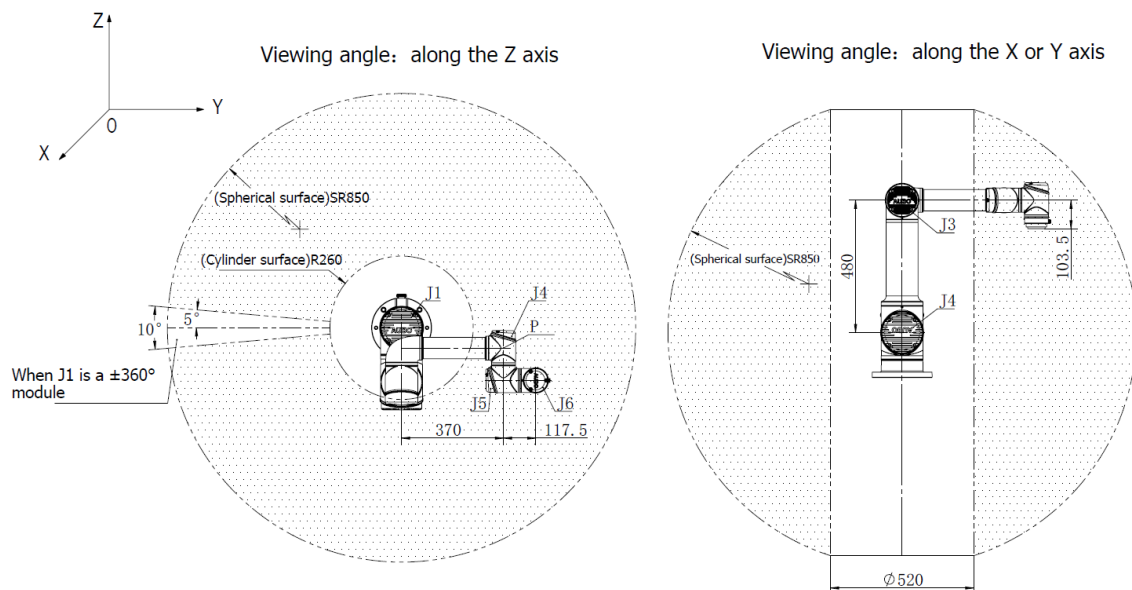

Figure 6-2 AUBO - i16 workspace illustration



The robot must work within an effective workspace.

6.4 Hardware Installation

6.4.1 Manipulator Base

AUBO robot manipulator base is shown in Figure 6-3.

The manipulator base has 4 anchor bolts for fixing the robot easily. When fixing the robot, rotate the Plum wheel to adjust the height of the anchor bolt, and tighten the nut to fix the robot. It is recommended to use an adjustable wrench to rotate the nut.



Figure 6-3 Diagram of manipulator base structure

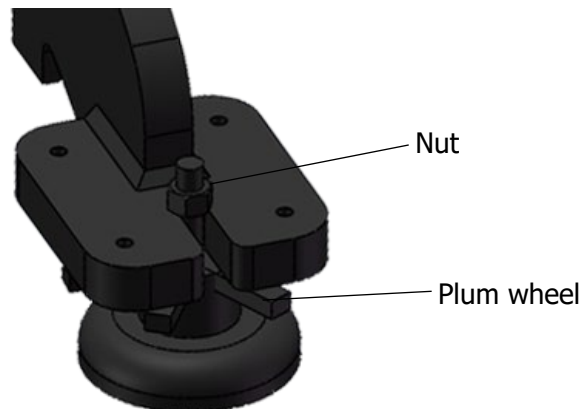

Figure 6-4 Diagram of the foot of the manipulator base structure

6.4.2 Manipulator Installation

The robot has a function of self-adaption for Installation pose. It can be installed in base, hoisting, mount on wall or any specific installation method, as shown below:

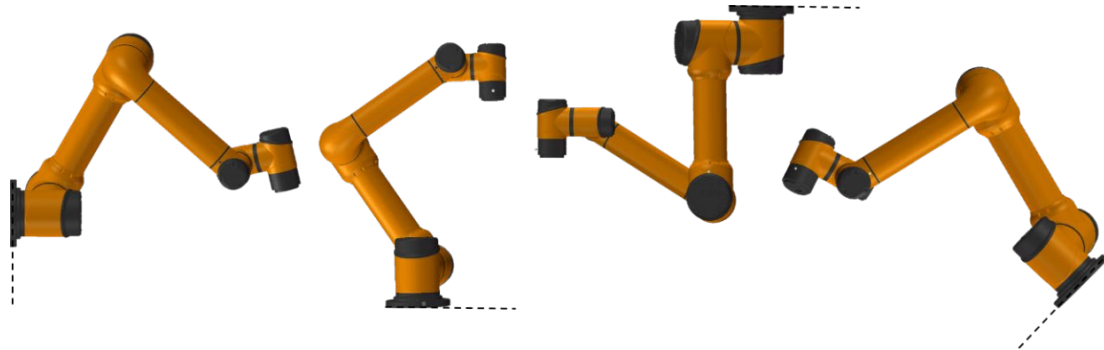

Figure 6-5 Diagram of different installation poses

Using **FOUR** M10 bolts to fix manipulator on the base. It's recommends using two $\Phi 8$ mm holes to install pins to improve the installation accuracy. Mechanical dimensions are shown in Figure 6-6.

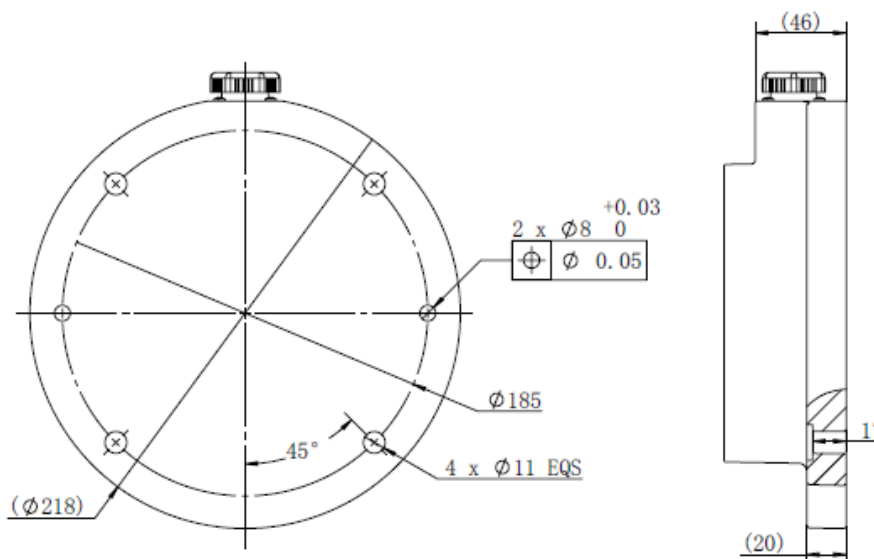

Figure 6-6 : Mounting whole size of the manipulator base.



1. When installing on the base, the robot and the base contact surface should be in close contact.
2. It is recommended that users use the base contact surface with strong heat dissipation performance, such as all-aluminum material. When the working environment exceeds 35 °C, it is strongly recommended that users use materials with strong heat dissipation performance.

6.5 End-effector Flange

End-effector flange has **Four** M6 threaded holes and a $\Phi 6$ positioning hole to fix the fixture on the end easily, as shown in Figure 6-8.

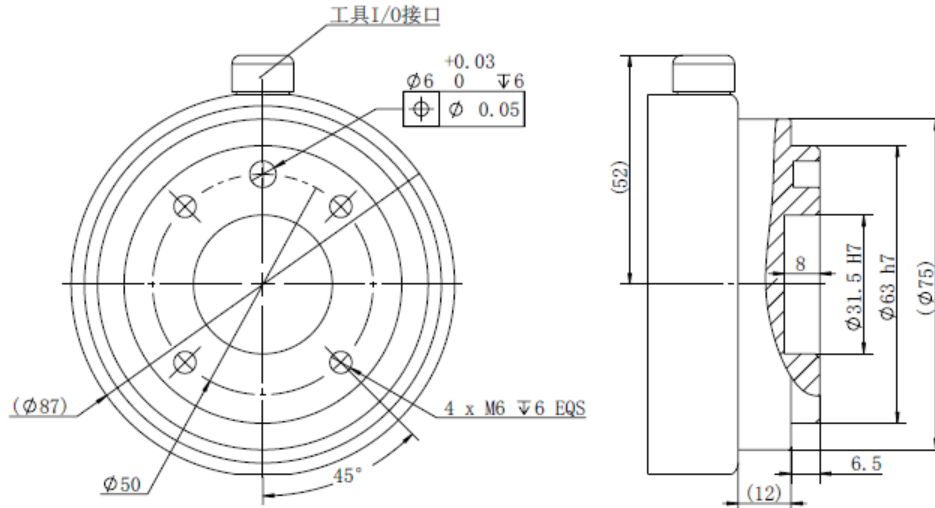

Figure 6-8 Mechanical dimensions of end-effector flange, unit: mm.



1. Make sure the tool is properly and safely bolted in place.
2. Make sure that the tool is constructed such that it cannot create a hazardous situation by dropping a part unexpectedly.

6.6 Cable Connection

There are 3 sockets on the bottom of the control box. There is a socket on the bottom of the robot body. There is a socket on the lower right side of the teach pendant. Insert the corresponding cable into the socket before use.

6.6.1 Teach Pendant Cable Connection

6.6.2 Teach Pendant Cable Connection

First unscrew the dust cap on the control box interface from the socket, and then insert the elbow round aviation plug of the teach pendant cable into the control box. Pay attention to the direction of insertion and tighten the locking ring after inserting it.

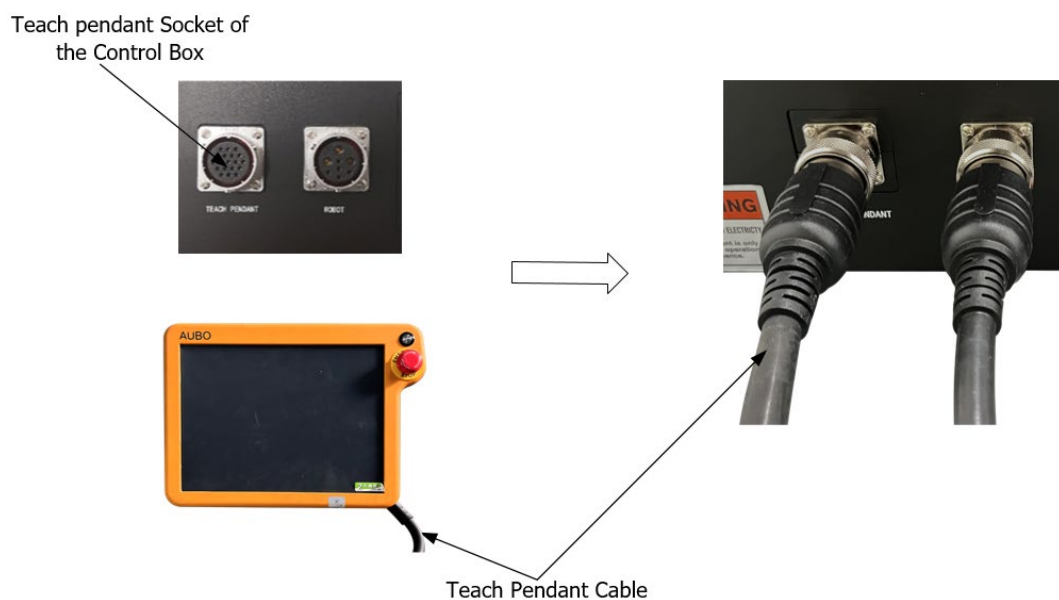

Figure 6-9 Teach pendant cable connected to control box

6.6.3 Manipulator Cable Connection

1. **Manipulator cable connected to the control box:** First unscrew the dust cap on the control box interface from the socket, and then insert the elbow round aviation plug of the Manipulator cable into the control box. Pay attention to the direction of insertion and tighten the locking ring after inserting it.

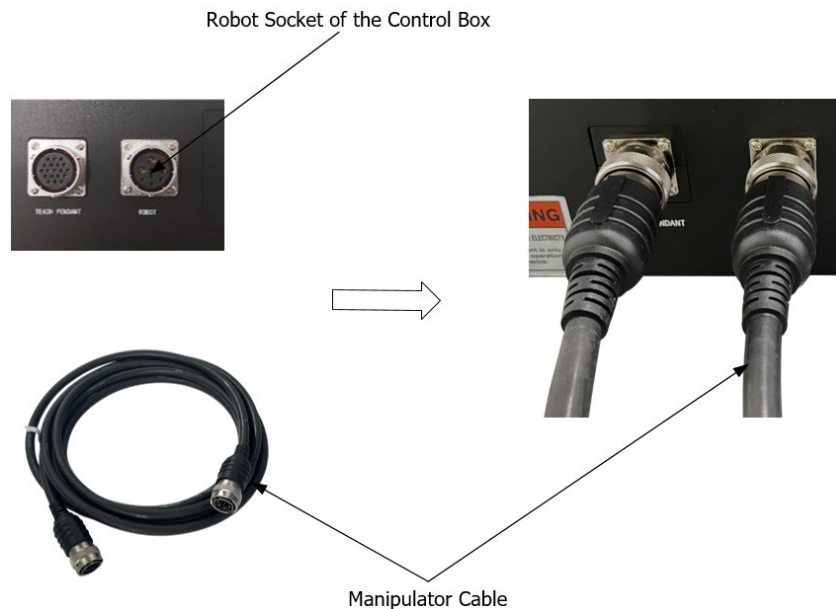

Figure 6-10 Manipulator cable connected to the control box

2. **Manipulator cable connected to the Manipulator:** First unscrew the dust cap on the robot body interface from the socket; align the pins of the plug and the socket with the socket respectively. The judgment mark is whether the gap on the socket and the protrusion on the plug are aligned, and then insert the plug. In the socket, rotate the fastening nut on the plug clockwise (in the direction of the plug toward the socket) until you hear a 'click', indicating that the connection is successful.

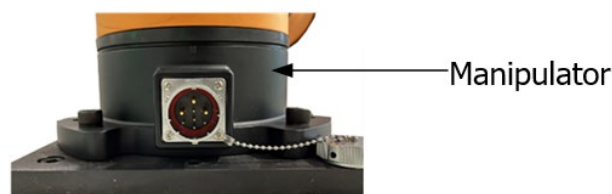

Figure 6-11 Manipulator cable connected to the Manipulator

6.6.4 Power Cable Connection

1. Connect the pin plug of the power cable to the power socket of the control box.

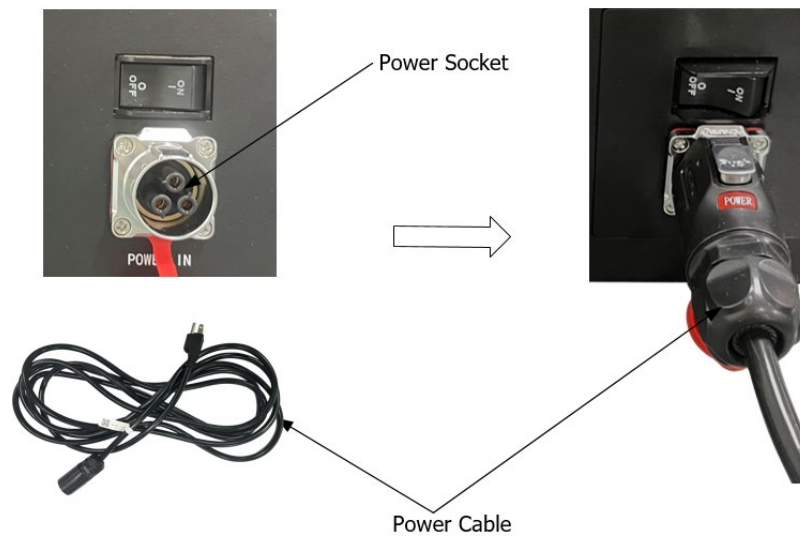

Figure 6-12 Power cable connected to the power socket

2. Connect the other end of power cable into the AC power outlet.



1. Make sure the robot is grounded (electrical ground) in the correct way. The grounding connector should have at least the rated current of the highest current in the system.

2. Make sure that all cables are properly connected before the control box is energized. Always use the original power cord correctly.



1. Never disconnect the robot cable while the robot arm is open.

2. Do not extend or modify the original cable.

7. Control Box

7.1 Introduction

Control box is the control center of AUBO robot, which contains a control board, a safety control board, a switching power supply and a safety protection device. The control box is powered by 100V-240V AC. Its 2 internal switching power supplies convert 100V - 240V AC into 12V, 24V and 48V DC which supply power for the load inside control box and the robot. Therefore, the connection between the robot and the teach pendant or the control box must be checked securely before use.

Control box is designed with hardware protection and software protection to ensure the security in the greatest degree when people use. Using multiple circuit breakers inside the control box plays a reliable role in short-circuit and overload protection on the hardware. With the emergency stop button in both the control box and the teach pendant, users can cut off robot's power in the shortest time to protect personnel and equipment.



Figure 7-1 Control box

7.2 Electrical Warnings and Cautions

The following warnings and cautions must be observed when a robot and control box application is designed and installed. The warnings and cautions also apply for service work.



Never connect safety signals to a PLC which does not fulfill the requirements of a correct safety level. Failure to follow this warning could result in serious injury or death due to the failure of the safety stop function.



1. Make sure that all non-waterproof equipment remains dry. If water comes inside the product, turn off all the power switches and then contact your supplier.

2. Use original cables supplied with the robot only. Do not use the robot for applications where the cables will be subjected to bent. Contact your supplier if longer or flexible cables are needed.

3. All mentioned GND connections are only for powering and transmitting signals. For Protective Earth (PE) use the screw connections marked with the earth symbols inside the control box. The grounding conductor shall have at least the current rating of the highest current in the system.

4. Be careful when installing the interface cables to the robot's I/O.

5. There are 100V-240V AC and 48V DC dangerous voltages in the box. Non-professionals should not open the cabinet with electricity.



Do not directly touch the screws and other metal parts inside the fastened control cabinet with your hands, and do not remove the wiring while electrified.

7.3 Control Box Panel Introduction

There are switches, buttons, indicators and electrical interfaces on the front panel and upper panel of the control box.

7.3.1 Front Panel

The front panel structure of the control box is shown in Figure 7-2 below.



Figure 7-2 Front panel of the control box

Table 7-1 Function description of switches, buttons and indicators on the front panel

Name	Function
TEACH PENDANT ENABLE/DISABLE	The teach pendant enable/disable switch
MANIPULATOR ON	The indicator lights up to indicate that the robot is powered on.
POWER	The indicator lights up to indicate that the external power is on.
STANDBY	When the indicator light is on, it indicates that the control box interface board program is initialized and the robot can be powered on by pressing the teach pendant power button.
EMERGENCY STOP	The indicator lights up to indicate that the robot is in emergency stop state.
MODE MANUAL/LINKAGE	Robot manual mode and linkage mode selection. When the button is pressed, the robot enters the linkage mode.
TEACH PENDANT	Teach pendant cable socket, connect the teach pendant cable.
ROBOT	Robot socket, connect the manipulator cable.
ON(I) / OFF(O)	Power switch, turn on or turn off the power.
POWER IN	Power socket, connect the power cable.

7.3.2 Side Panel

Fans are provided on both sides of the control box.



Figure 7-3 Side panel of the control box

7.3.3 Upper Panel

The Ethernet interface and USB interface are provided on the upper panel of the control box, as shown in below figure.

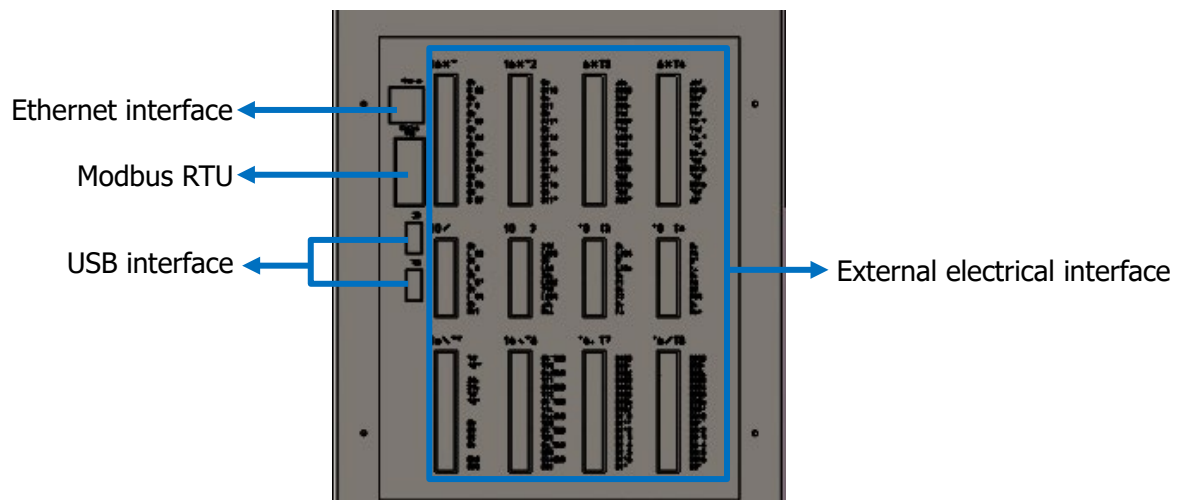

Figure 7-4 Communication interface on the upper panel of the control box

Table 7-2 Description of the upper panel interface

Number	Interface	Function
1	Ethernet interface	Remote access and control.
2	Modbus RTU interface	Connected to a Modbus device.
3	USB interface	Used to update software, import, and export project files.
4	External electrical interface of control box	Provide external I/O interface.

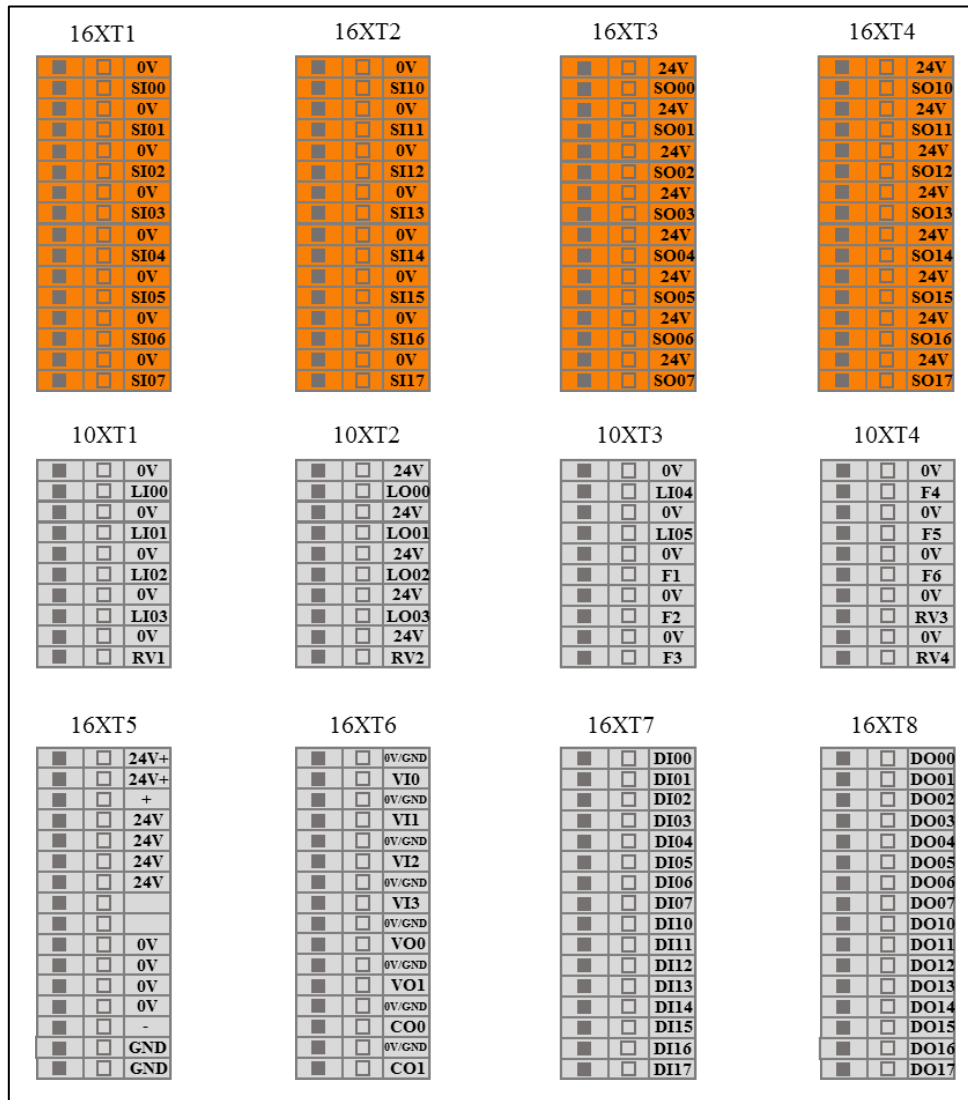

Figure 7-5 Schematic diagram of the external electrical interface of the control box



It is forbidden to plug and unplug the USB device while the robot is running.

7.4 Selection of Working Mode

The robot system has two working modes, “Manual” and “Linkage”, which are selected by MODE MANUAL/LINKAGE switch. When changing the working mode of the robot system, it is necessary to select the specified working mode after power off, and then restart the teach pendant and the robot.

7.4.1 Manual Mode

In manual mode, the external signal sent to the robot through the linkage mode IO cannot control the robot. This mode is generally suitable for working conditions with only one robot.

- Power on: Turn on the power switch of the control box and wait until the STANDBY indicator lights up. Press the teach pendant start button for about 1 second and then the robot system is powered on.
- Force control button: When the robot in AUBOPE software is at “teaching” mode, press and hold the teach pendant force control button to the middle position, drag the robot to the target position, and release the button.
- Emergency stop: Press the emergency stop button on the teach pendant to power off the robot. Rotate the emergency stop button to reset the emergency status, follow the instruction of the teach pendant interface to restart the AUBOPE software, and the robot will power on again.
- Shutdown:
 - Normal exit: Press the software shutdown button in the upper right corner of the AUBOPE software to exit the program and shut down the teach pendant.
 - Forced shutdown: press and hold the start button in the upper left corner of the teach pendant for about 3s, the blue light will be off, then the teach pendant and the robot will be powered off.

7.4.2 Linkage Mode

In “Linkage” mode, the robot can communicate with one or more external devices (manipulators, etc.) through the linkage mode IO port. This mode is generally suitable for coordinated operation between multiple robots.

Table 7-3 IO function and status description in linkage mode

Input	Interface board IO function and status
LI00	In linkage mode, program start signal input port.
LI01	In linkage mode, program stop signal input port.
LI02	In linkage mode, program pauses signal input port.
LI03	In linkage mode, program returns to the initial position signal input port.
LI04	Remote power-on signal input port (can also be used in non-linked mode).
LI05	Remote shutdown signal input port (can also be used in non-linked mode).
F6	Warning/error message clearing input port.
Output	Interface board IO function and status
LO00	In linkage mode, program running signal output port.
LO01	In linkage mode, program stop signal output port.
LO02	In linkage mode, program paused signal output port.
LO03	In linkage mode, program returned to the initial position signal output port.

Example:

The case below demonstrates how to use external device to manipulate the robot under linkage mode.

- **Software preparation:**

1. When the robot is initialized, the selection of the Tool Name must be consistent with the load installed on the real manipulator. If it is inconsistent, the manipulator may be abnormal.

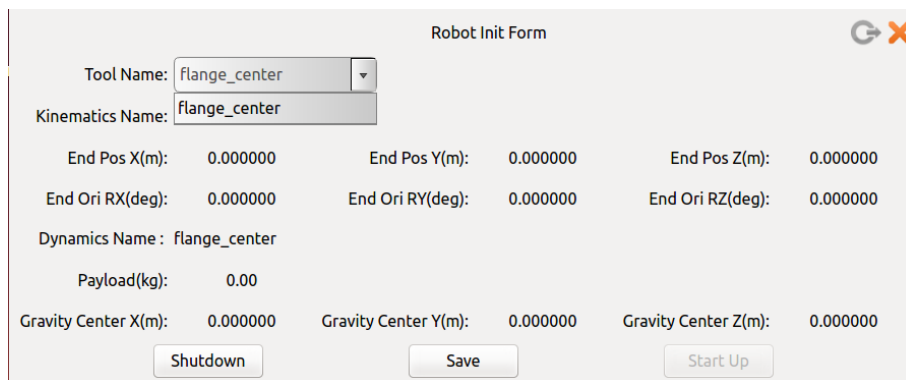

The screenshot shows the 'Robot Init Form' window. It contains the following fields and values:

- Tool Name: flange_center
- Kinematics Name: flange_center
- End Pos X(m): 0.000000
- End Pos Y(m): 0.000000
- End Pos Z(m): 0.000000
- End Ori RX(deg): 0.000000
- End Ori RY(deg): 0.000000
- End Ori RZ(deg): 0.000000
- Dynamics Name: flange_center
- Payload(kg): 0.00
- Gravity Center X(m): 0.000000
- Gravity Center Y(m): 0.000000
- Gravity Center Z(m): 0.000000

At the bottom, there are three buttons: 'Shutdown', 'Save', and 'Start Up'.

Figure 7-6 Robot initialization

2. Set target project as "Default Project" in AUBOPE software.

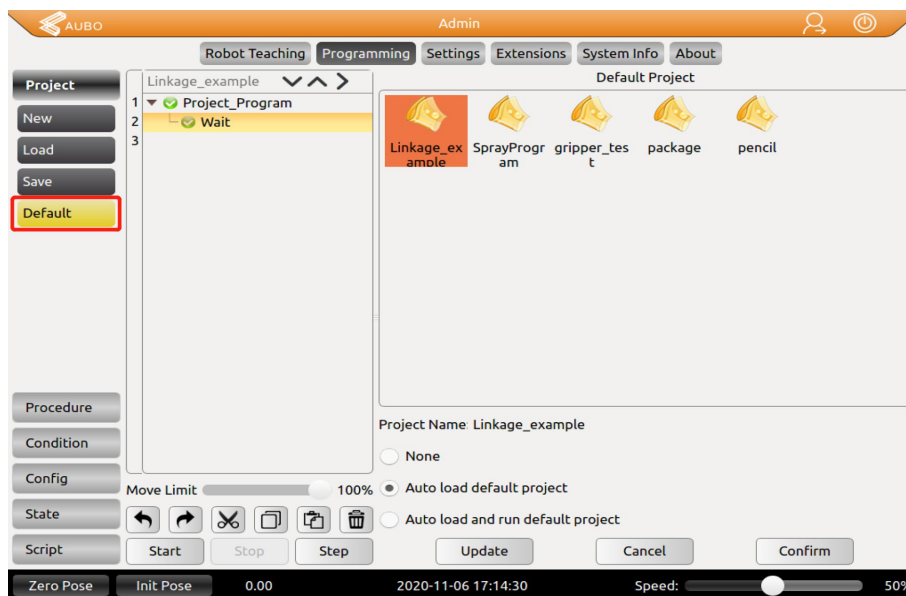

Figure 7-7 AUBOPE software "Programming" tag

3. In "Safety Config" page of the AUBOPE software, click "Enable Force Control in Non-Stop State" box to make sure force control function is enable in "Linkage" mode. (Optional)

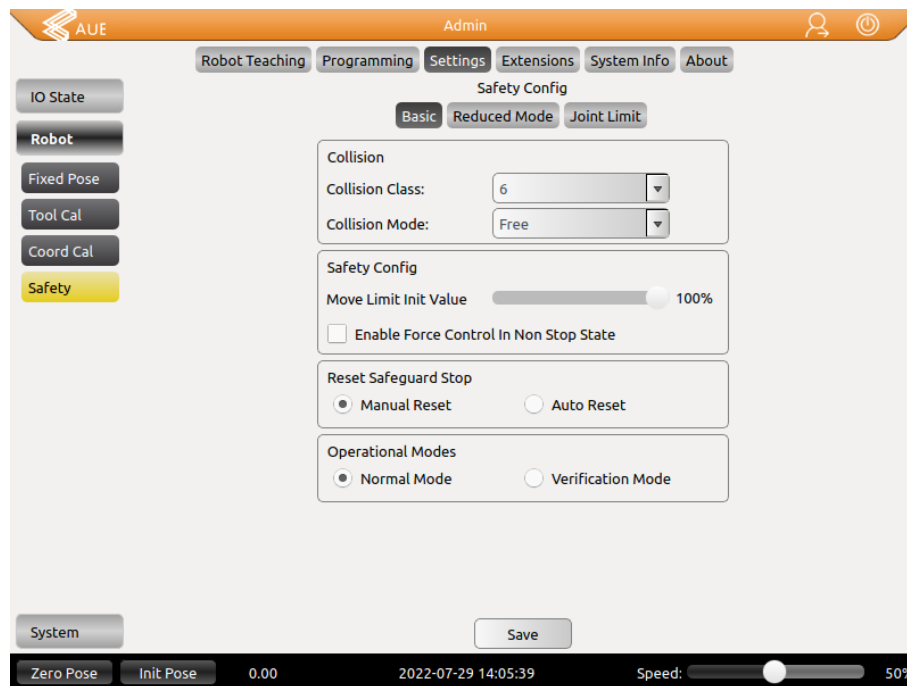

Figure 7-8 AUBOPE software "Setting" tag

4. Shutdown the teach pendant and power off the robot.

- **Hardware preparation:**

1. Connect IO ports of the control box with external devices according to the picture shown below. Y2, Y7 are self-locking switches (press the switch to turn on, press it again to turn off), others are reset switches (press the switch to turn on, release the switch to turn off).

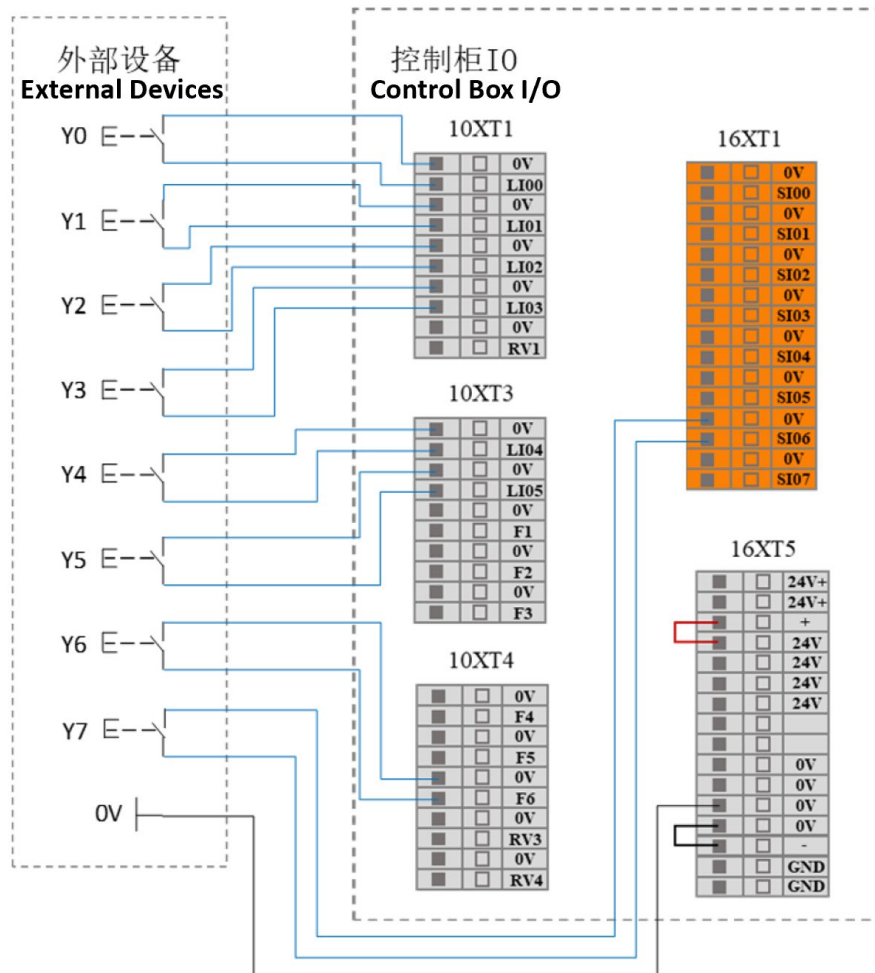

Figure 7-9 Connect IO ports of the control box with external devices

2. Press the "MODE MANUAL/LINKAGE" button on the control box panel.
3. Power on the system (By sending external signal to Y4/LI04).

Table 7-4 External device's function list

Input	Interface board IO function and status
LI00 (Y0)	In linkage mode, program start signal input port
LI01 (Y1)	In linkage mode, program stop signal input port.
LI02 (Y2)	In linkage mode, program pauses signal input port.
LI03 (Y3)	In linkage mode, program returns to the initial position signal input port.
LI04 (Y4)	Remote power-on signal input port (can also be used in non-linked mode)
LI05 (Y5)	Remote shutdown signal input port (can also be used in non-linked mode)
F6 (Y6)	Warning/error message clearing input port.
SI06 (Y7)	Force teaching function enable input port.
Output	Interface board IO function and status
LO00	In linkage mode, program running signal output port.
LO01	In linkage mode, program stopping signal output port.
LO02	In linkage mode, program paused signal output port.
LO03	In linkage mode, program returned to the initial position signal output port.
SO07	AUBOPE running status output port.

4. The specific operation is as follows:

Function	Operation	Phenomenon
System power on	Press Y4 (LI04)	When the control box is power on, LO01 outputs valid signal After the software is power on, SO07 outputs valid signal, but at least 10 seconds of waiting is required to continue following operations.
Move robot to Initial position	Keep pressing Y3 (LI03) till the robot moved to the initial	When the robot moved to the initial position, LO03 position outputs valid signal.
Start project, robot start moving	Press Y0 (LI00)	When the robot starts moving, LO01 outputs invalid signal LO03 outputs invalid signal LO00 outputs valid signal
Robot Pause	Press Y2 (LI02)	LO00 outputs invalid signal LO02 outputs valid signal
Robot continue to move after pause	Press Y2 (LI02)	LO00 outputs valid signal LO02 outputs invalid signal
Robot continue to move after collision	Press Y6 (F6) to clear the warning message, then press Y2 (LI02) to let robot continue to move	After collision: LO00 outputs invalid signal LO02 outputs valid signal after start moving: LO00 outputs valid signal LO02 outputs invalid valid signal
Robot stops moving	Press Y1 (LI01)	LO00 outputs invalid signal LO01 outputs valid signal
Enter Drag-teaching Mode	Press and hold Y7 (SI06), start drag-teach, release Y7 (SI06) disable drag-teach mode	---
Clear Warning Message	Press Y6 (F6)	---

Function	Operation	Phenomenon
Robot collides during movement, drag teach the robot to a new pose then continue to move	When robot collides during movement, it will automatically switch to drag-teaching mode. You will need to drag the robot to an appropriate pose, press Y6 (F6) to clear warning message, then press Y2 (LI02) twice to let robot continue to move	When robot is moving, LO00 outputs valid signal When robot stops after collision, LO00 outputs invalid signal LO02 outputs valid signal When robot continues to move LO00 outputs valid signal LO02 outputs invalid signal
Robot collides during movement of returning to initial position, continue to move	Press Y6(F6) to clear the warning message, then keep pressing Y3(LI03) till the robot moves to the initial position	When robot is moving to the initial position, LO01 outputs valid signal when robot moved to the initial position, LO03 outputs valid signal
Robot collides during movement of returning to initial position, drag-teach the robot to a new pose then continue to move	When robot collides during movement, it will automatically switch to drag-teaching mode. You will need to drag the robot to an appropriate pose, press Y6 (F6) to clear warning message, then keep pressing Y3 (LI03) till to move the robot moves to the initial	When robot is moving to the initial position, LO01 outputs valid signal when robot moved to the initial position, LO03 outputs valid signal

In linkage mode, if you don't need to use the teach pendant, after setting the default program and other parameters, you can press the "TEACH PENDANT ENABLE/DISABLE" button on the control box. Then remove the teach pendant and its cable.

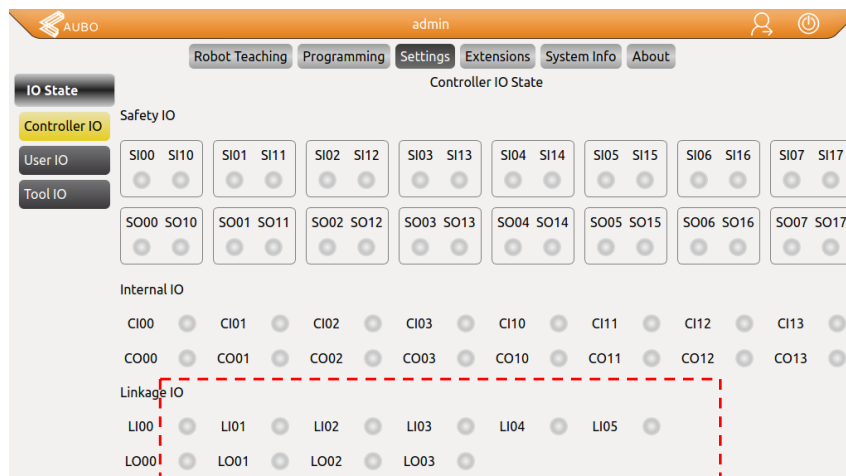

Figure 7-10 AUBOPE software "Settings" tag, Linkage IO status

When the teach pendant is enabled, at "settings" tag, when the signal is valid, the indicator light of the corresponding interface will light up.

7.5 Teach Pendant Enable/Disable Button

The Teach Pendant Enable/Disable Button is used in the case when the teach pendant is not needed, such as in linkage mode. Under normal circumstances, this button is popped up, and the teach pendant can be used normally (the emergency stop of the teach pendant is available). If the user needs to unplug the teach pendant, they can press this button. At this time, the teach pendant and the emergency stop button of the teach pendant are disabled. You can unplug the teach pendant cable and use the IO interface signals to control the robot.

The Teach Pendant Enable/Disable Button is located on the front panel of the control box, as the picture shown below:



Figure 7-11 Control box panel



1. To turn on or off the teach pendant enable switch, the control box must at power off status.
2. External emergency stop button/device is required when the teach pendant is disabled.

8. Electrical Interface

8.1 Electrical Warnings and Cautions

The following warnings and cautions must be observed when a robot and control box application is designed and installed. The warnings and cautions also apply for service work.



1. Never connect safety signals to a PLC which does not fulfill the requirements of a correct safety level. Failure to follow this warning could result in serious injury or death due to the failure of the safety stop function.
2. The control box must be powered off when the electrical interface is wired.
3. All safety signals have dual loop safety channels (redundant design). Keeping the two channels independent ensures that no safety function is lost in the event of a single failure.



1. Make sure that all non-waterproof equipment remains dry. If water comes inside the product, turn off all the power switches and then contact your supplier.
2. Use original cables supplied with the robot only. Do not use the robot for applications where the cables will be subjected to bent. Contact your supplier if longer or flexible cables are needed.
3. All mentioned GND connections are only for powering and transmitting signals. For Protective Earth (PE) use the screw connections marked with the earth symbols inside the control box. The grounding conductor shall have at least the current rating of the highest current in the system.
4. Be careful when installing the interface cables to the robot's I/O.



1. Interference signals higher than the level specified in the IEC standard will cause the abnormal behavior of the robot. Extremely high signal levels or excessive exposure can damage the robot permanently. EMC problems usually occur in welding processes and are normally prompted by an error message in the log. AUBO (Beijing) Robotics Technology Co., Ltd is not responsible for the loss caused by the EMC problem.
2. I/O cables going from the control box to other machinery and factory equipment may not be longer than 30m, unless extended tests are performed.

8.2 Control Box Communication Interface

The control box provides a variety of electrical interfaces for connecting external devices that are easily accessible to the user.

Remove the back cover of the upper panel of the control box. The panel provides Ethernet interface, Modbus RTU interface, USB interface and some electrical interfaces (Refer to 7.3.3 Upper Panel).

➤ Ethernet interface

The Ethernet interface can be used for remote access and control. Users can refer to 10.6.3 Network Settings to connect external control devices.

➤ Modbus device interface

The Modbus device interface is located on the upper panel of the control box (Refer 7.3.3 Upper Panel). Modbus devices can be connected via the USB interface and the Modbus RTU interface.

The Modbus RTU interface pin description is shown below:

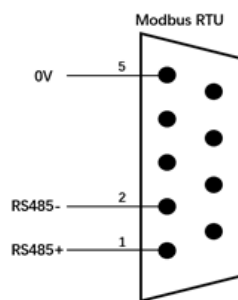

Figure 8-1 Modbus pin description

➤ USB interface

The USB interface is located on the back panel and side panel of the control box (see 7.3 Control box panel) for device connection, software upgrade and project file export (see 10.6.6 update for usage).

8.3 Control Box I/O Power Supply

8.3.1 Internal Power Supply

The control box panel IO defaults to the internal power supply mode, as shown in the following figure:

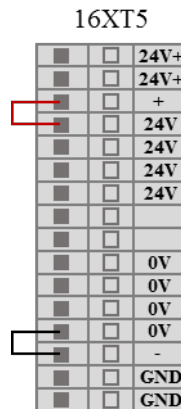

Figure 8-2 Internal power supply schematic

8.3.2 External Power Supply

If the user needs to use external power supply, please use the following wiring method.

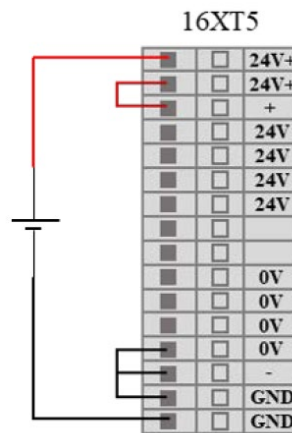

Figure 8-3 external power supply schematic



When the electrical interface of the control box is wired, the control box must be powered off.

8.4 Safety I/O

8.4.1 Introduction

The safety I/O is designed as dual channel (redundant design) to ensure the safety function shall not lost in any case of single failure. The safety devices and equipment must be implemented in accordance with the safety instruction and finished the comprehensive risk assessment before use. The safety I/O is located on the orange terminal block on the back panel of the control box and needs to be retained in two branches.

8.4.2 Safety Tips



1. Never connect safety signals to unsafety PLC which is not in correct safety level.
2. Be sure to separate the safety I/O signal with normal I/O signal.
3. Ensure to check the safety function before using the robot, and the safety function must be tested regularly.

8.4.3 Safety I / O Function Definition

The safety I/O are orange color in the external panel of the control box. The safety functions are defined as following:

Input/Output	IO Name		IO Function
Input	SI00	SI10	External Emergency Stop
	SI01	SI11	Safeguard Stop
	SI02	SI12	Reduced Mode
	SI03	SI13	Safeguard Stop Reset
	SI04	SI14	Three-Position Enabling Device
	SI05	SI15	Operational Mode
	SI06	SI16	Force Control Enable
	SI07	SI17	Robot System Stop
Output	SO00	SO10	Robot Emergency Stop (Normally Open)
	SO01	SO11	Robot Moving
	SO02	SO12	Robot Not Stopping
	SO03	SO13	Robot in Reduced Mode
	SO04	SO14	Robot in non-Reduced Mode
	SO05	SO15	System Error
	SO06	SO16	Robot Emergency Stop (Normally Close)
	SO07	SO17	Robot System Running

There are two safety related electrical inputs:

- External Emergency Stop input: only used to stop the system completely under case of emergency.
- Safeguard Stop input: used for conducting category 2 stop.

Function difference is shown below:

Table 8-1 Difference between external emergency stop and safeguard stop

	Emergency Stop	Safeguard Stop
Robot Stop Moving	Yes	Yes
Program status	Stop	Pause
Robot power status	Off	On
Reset	Manual	Manual / Auto
Usage frequency	Infrequent	Every cycle to infrequent
Reinitialization	Brake release only	No
Stop category	1	2

Table 8-2 Safety related electrical input performance

Safety Input Functions	Worst Case		
	Detection time	Power off time	Response time
External Emergency Stop	100ms	1200ms	1300ms
Safeguard Stop	100ms	—	1200ms
Reduced Mode Input	100ms	—	1200ms
Safeguard Stop Reset	100ms	—	1200ms
Enabling Device	100ms	—	1200ms
Operational Mode	100ms	—	1200ms
Teach Pendant Emergency Stop	100ms	1200ms	1300ms
System Stop Input	100ms	—	1200ms

Table 8-3 Safety related electrical output performance

Safety Output	Worst case responding time	Safety Output	Worst case responding time
Robot Emergency Stop	1000ms	REDUCED MODE	1000ms
Robot Moving	1000ms	NON-REDUCED MODE	1000ms
Robot Not Stopping	1000ms	SYSTEM ERROR	1000ms

8.4.4 Default Safety Configuration

The robot is shipped with a default configuration as below. In this case, the robot can be operated without any additional safety equipment.

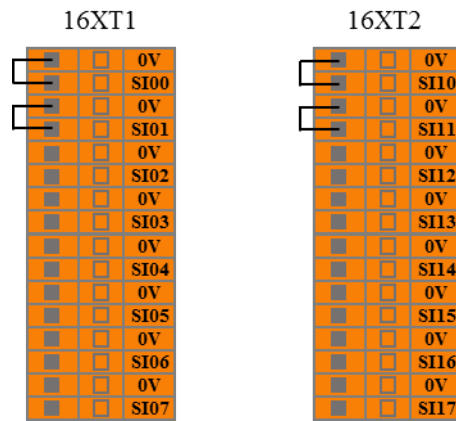

Figure 8-4 Default safety configuration

8.4.5 External Emergency Stop Input

When one or more external emergency stop devices is required for robot application, users can connect those devices as below.

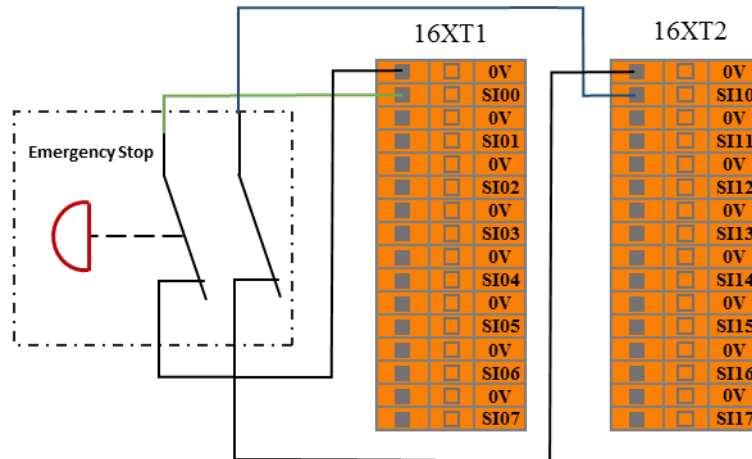

Figure 8-5 External emergency stop input

8.4.6 Safeguard Stop Input

User can connect external safety devices (such as safety light curtains, safety laser scanners, etc.) through this interface, then control the robot to enter the safeguard stop state.

When configuring **auto-reset** safeguard stop, the user can refer to the following example, using the safety light curtain to connect to the safeguard stop input ports. See below:

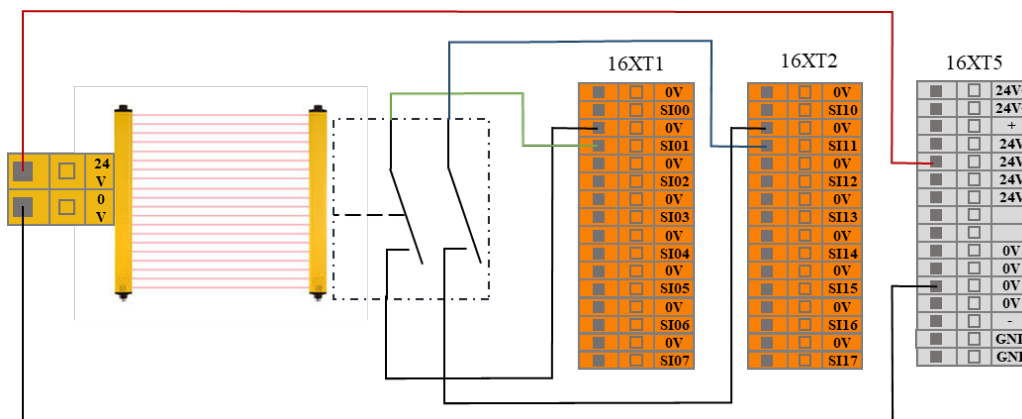



Figure 8-6 Safeguard stop input (Internal Power Supply)

After the operator enters the safety zone, the robot stopped moving and maintained category 2 stop. After the operator leaves the safety zone, the robot starts automatically from the waypoint where it stopped. During this process, there is no need to use protective reset input.



1. In this mode, the system response time is 1200ms. If the user call this stop too frequently, the system may report errors.
2. In this configuration, user should select the protective reset as **manual reset** via AUBOPE "Settings" tag.

When configuring **manual reset** safeguard stop, the user can refer to the following example, using the safety light curtain to connect to the safeguard stop input ports, and deploy an external safeguard reset button that connects to the safeguard reset input ports. See below:

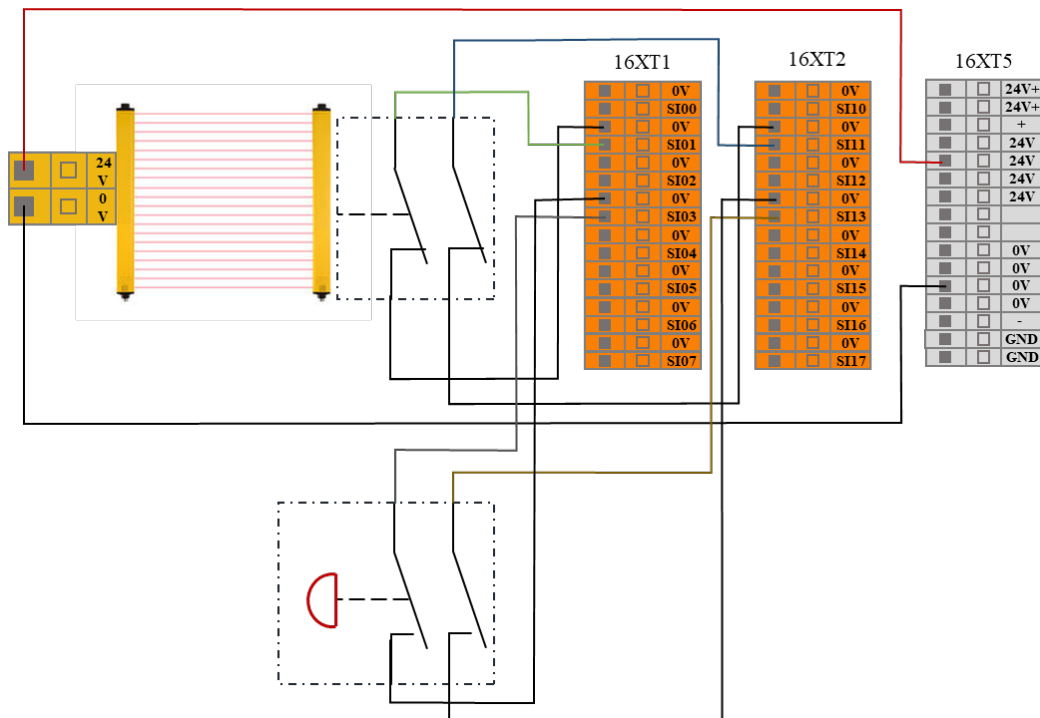



Figure 8-7 Safeguard stop input (Internal Power Supply)

After the operator enters the safety zone, the robot stopped moving and maintained category 2 stop. When the operator leaves the safety zone, the system needs to be reset from the outside of the safety zone by pressing the reset button. Then the robot will continue to run from the stop point. During this process, a protective reset input is required.



1. In this mode, the system response time is 1200ms. If the user call this stop too frequently, the system may report errors.
2. In this configuration, user should select the protective reset as **auto reset** via AUBOPE "Settings" tag.

8.4.7 Reduced Mode Input

The user can use this port to control the robot enters the reduced mode. In this mode, the motion parameters (joint speed, TCP speed) of the robot are limited to user-defined reduced mode range.

The user can refer to the following example, using a safety mat to connect to the reduced mode input interface. See below:

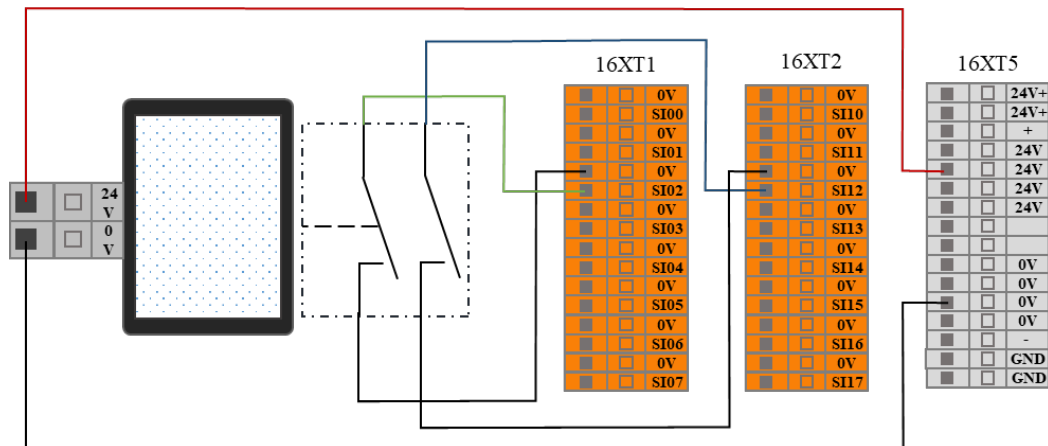

Figure 8-8 Reduced mode input connection

When the operator enters the safety zone, the robot enters the reduce mode, and the motion parameters (joint speed, TCP speed) of the robot are limited to user-defined reduced mode range. After the operator leaves the safety zone, the robot exits the reduced mode and enters the normal mode.



1. In this mode, the system response time is 1200ms. If the user call this stop too frequently, the system may report errors.
2. When using this type of configuration, the user needs to configure the reduced mode motion parameters through the AUBOPE "Settings" tag.

8.4.8 Safeguard stop Reset Input

When configure the safeguard stop with reset device, users can use this interface to connect external reset devices (reset buttons, etc.).

Refer to the following example, connect the safety light curtain to the safeguard stop input terminal and use the safety reset button to connect to the safeguard stop reset input terminal. See the next figure.

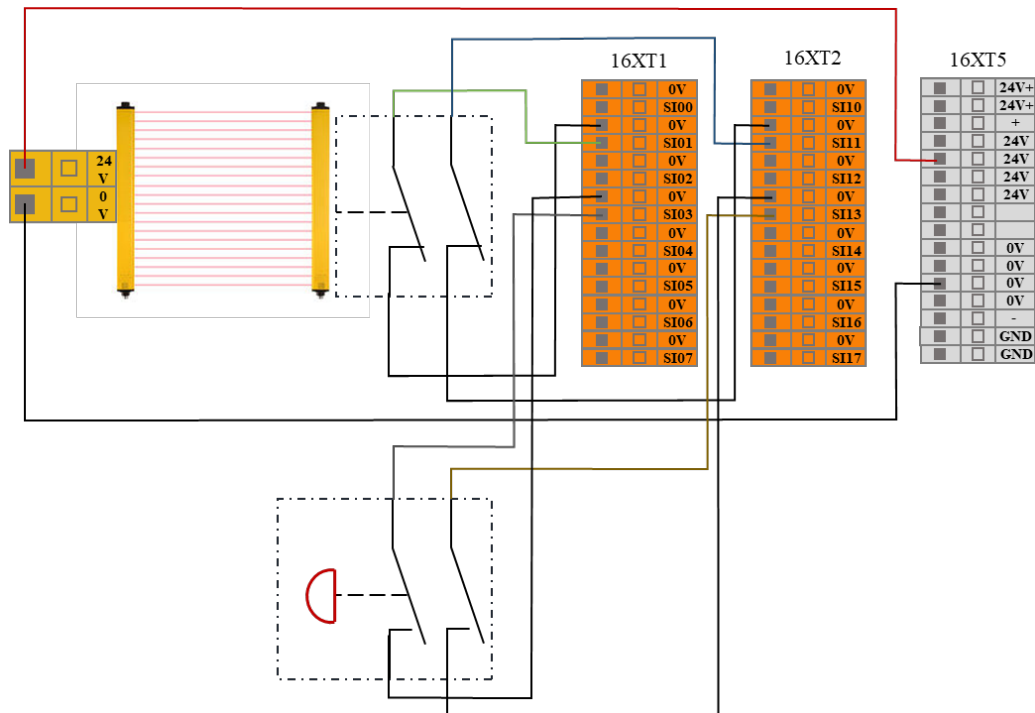

Figure 8-9 Safeguard stop Reset Input connection (Internal power supply)

After the operator enters the safety zone, the robot stopped moving and maintained category 2 stop. When the operator leaves the safety zone, the system needs to be reset from the outside of the safety zone by pressing the reset button. Then the robot will continue to run from the stop point. During this process, a protective reset input is required.



When using this type of configuration, the user needs to configure the protective reset as manual reset through the AUBOPE.

8.4.9 Three-Position Enabling Device Input

User can use this port to connect external safety devices (such as three-position enabling switch, etc.), to verify the project. The user can refer to the following example, using the three-position enabling switch to connect the enabling device input interface. See below.

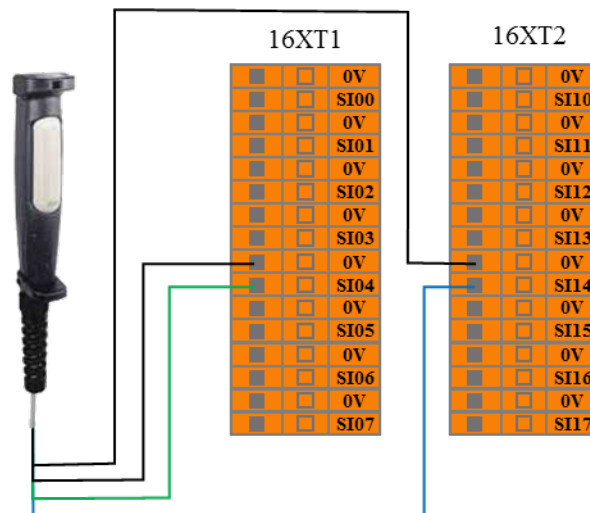

Figure 8-10 Enabling device input connection

In verification mode, the robot moves only when the three-position enable switch is in the enable position (intermediate position); when the user releases or presses the three-position enable switch, make the three-position switch enter non-enabled position, the robot will pause its movement.



When using this configuration, the user must ensure the robot is in "Verification" mode. User can set the robot to this mode through AUBOPE "Settings" tag, or the user can also use the operation mode input ports to set the robot to verification mode

8.4.10 Operational Mode Input

Users can use this interface to connect an external safety device (mode selector switch, etc.) and select the robot's working mode. The user can refer to the following example, using the safety selector switch to connect to the operation mode input interface. See below.

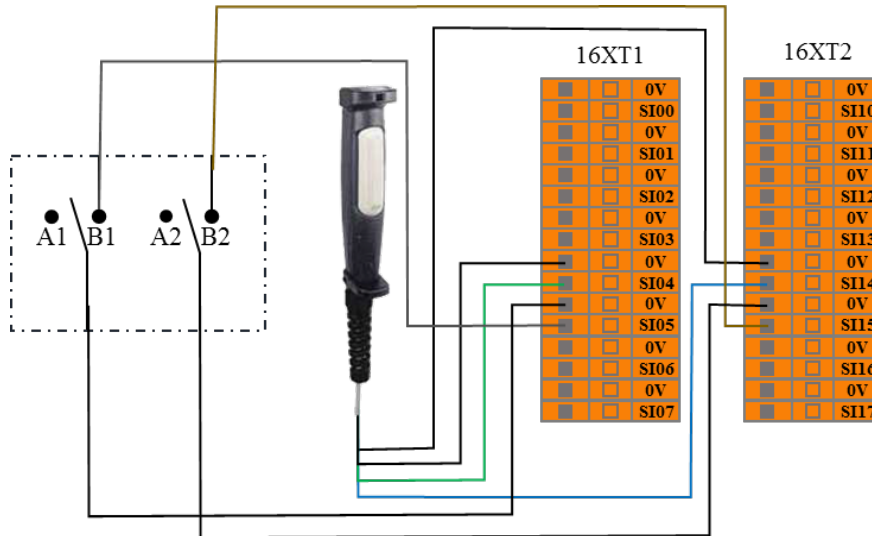

Figure 8-11 operation mode input connection

When the user switches the selector switch to A position, the robot enters normal mode, and the user can operate the robot normally.

When the user switches the selector switch to B position, the robot enters verification mode. In this mode, only when the enabling device input is valid, can the robot execute the target project and operations. When the enabling device input is invalid, the robot will pause its movement immediately.

8.4.11 Force Control Enable Input

The user can use these ports to receive external force control enable signals, to enable the robot enters force control mode. The user can refer to the following example, enable the robot's force control function without using the force control button in the teach pendant.

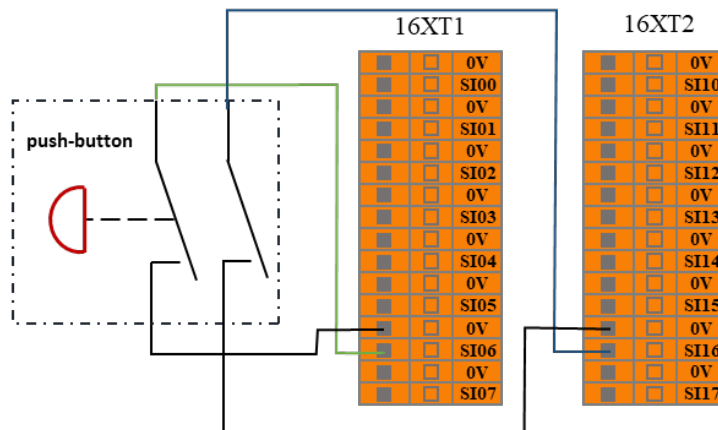

Figure 8-12 Force control enable input

8.4.12 System Stop Input

The user can use these ports to receive external stop signal inputs and enable the robot to enter a category 1 stop. These inputs can be used in multi-machines collaboration mode, by setting a common emergency stop line and sharing emergency stop with other machines. The operator can use the emergency stop button of one machine to control the entire line of the machines into an emergency stop state.

The user can refer to the following example, the two robots can transfer the emergency stop state according to their connection. In this system, the emergency stop output connected to the system stop input terminal. See below.

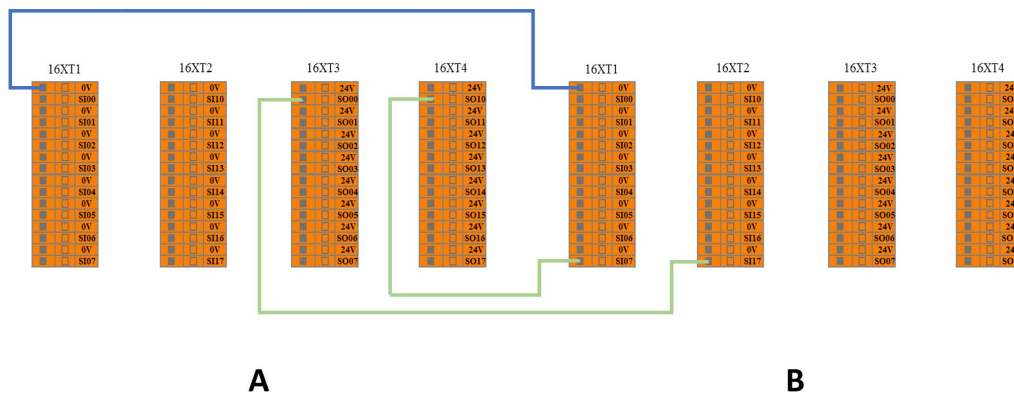

Figure 8-13 System stop input connection (From A to B)

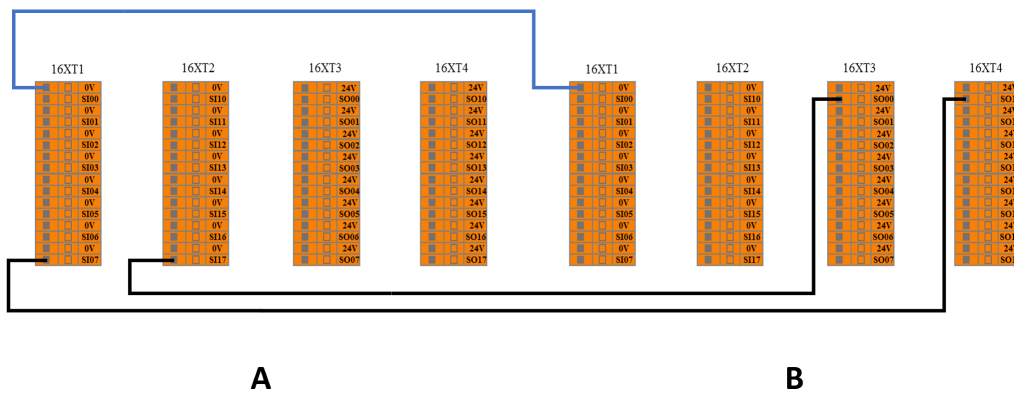

Figure 8-14 System stop input connection (From B to A)

In Figure 8-13, when A has an emergency stop, B will also stop simultaneously. But when B has an emergency stop, A will not be interfered.

In Figure 8-14, the situation is reversed. When B has an emergency stop, B will also stop simultaneously. But when A has an emergency stop, B will not be interfered.

In other words, the emergency stop state sharing mechanism is a one-way transfer process. It can transfer A → B → or → B → A.

Therefore, the following connection method (Figure 8-15) is **prohibited**.

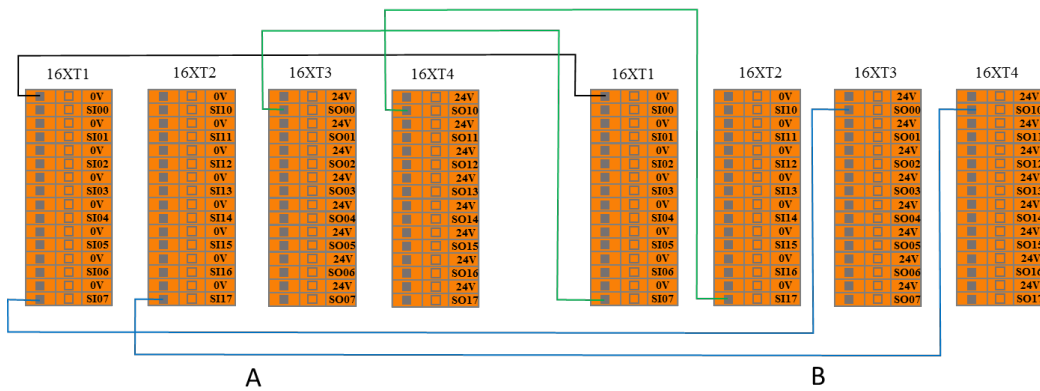

Figure 8-15 **Prohibited** system stop input connection

With this connection, the two system will enter an interlock state. Each system falls in to emergency status until the connection loop is manually interrupted (disconnect the one pair of input or output).

8.4.13 Robot Emergency Stop Output (NO)

This port outputs signal when the robot enters the emergency stop state.

The user can refer to the following example to setup an external alarm light to the system emergency stops output port. See below.

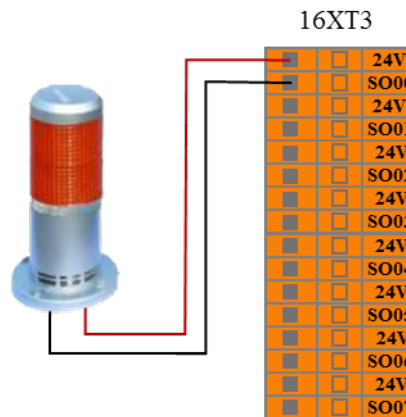



Figure 8-16 Robot emergency stops output connection

Under this configuration, when the robot enters the emergency stop state, it outputs a system emergency stop signal and the external alarm light will on.



This function is widely used, in any case, a complete risk assessment is required for users.

8.4.14 Robot Moving Output

This port outputs signal when the robot moves normally.

The user can refer to the following example to connect an external indicator to the robot moving output port. See below.

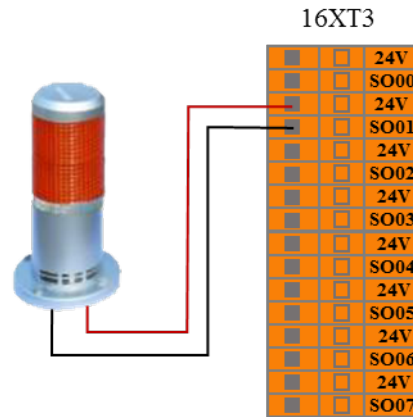

Figure 8-17 Robot moving output connection

Under this configuration, when the robot moves, the external robot moving indicator light will on.



This function is widely used, in any case, a complete risk assessment is required for users.

8.4.15 Robot Not Stopping Output

This port outputs signal after the robot receives stop signal, decelerates its movement, and has not yet completely stopped.

The user can refer to the following example to connect an external indicator to this robot not stopping output port. See below:

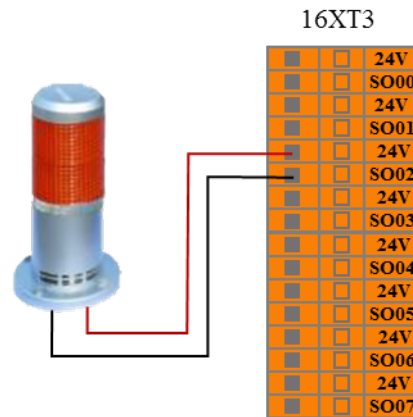

Figure 8-18 Robot not stopping output connection

Under this configuration, after the robot receives stop signal and decelerates its movement, and has not yet completely stopped, the external robot not stopping status indicator light will on.



This function is widely used, in any case, a complete risk assessment is required for users.

8.4.16 Reduced Mode Output

This port outputs signal when the robot enters reduced mode.

The user can refer to the following example to connect an external indicator to this reduced mode output port. See below:

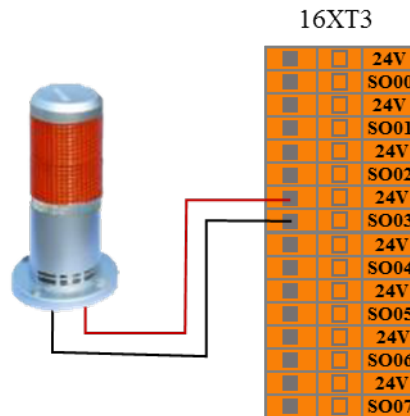

Figure 8-19 Reduced mode output connection

Under this configuration, when the robot enters reduced mode, the external reduction mode indicator light will on.



This function is widely used, in any case, a complete risk assessment is required for users.

8.4.17 Non-Reduced Mode Output

This port outputs signal when the robot enters non-reduced mode.

The user can refer to the following example to connect an external indicator to the non-reduced mode output port. See below:

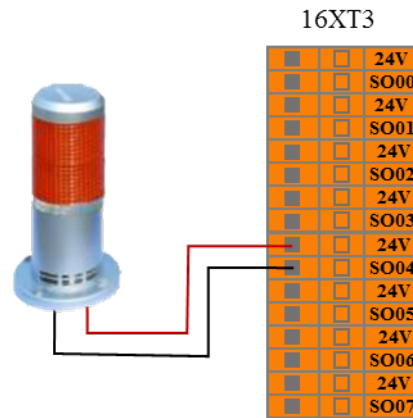

Figure 8-20 Not reduced mode output connection

Under this configuration, when the robot enters the not reduced mode, the external non-reduction mode indicator light will on.



This function is widely used, in any case, a complete risk assessment is required for users.

8.4.18 System Error Output

This port outputs signal when the robot system has an error.

The user can refer to the following example to connect an external indicator to the system error output port. See below:

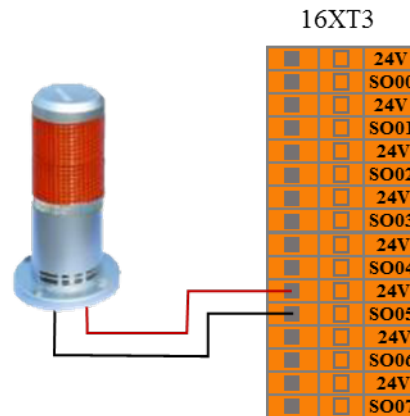

Figure 8-21 System error output connection

Under this configuration, when the robot system error alarms, the external system error indicator light will on.



This function is widely used, in any case, a complete risk assessment is required for users.

8.4.19 Robot Emergency Stop (NC)

When the robot does not have an emergency stop, these ports continuously output signals. The relationship between these ports and the 8.5.13 external emergency stop output (NO) is "NOT". The user can use this signal port to stop multiple robots at the same time.

The user can refer to the following example to connect other robot system, see the figure below:

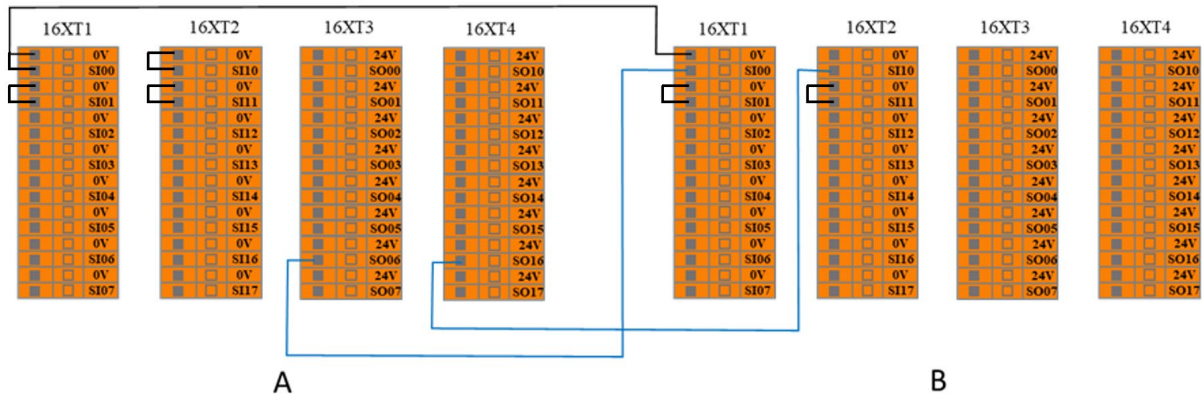

Figure 8-22 Robot emergency stop (NC) output sharing mechanism connection

8.4.20 AUBOPE Operation Indication Output

This port outputs signal when the AUBOPE software is running.

Users can refer to the following example to connect an external indicator to AUBOPE operation indication port. See below:

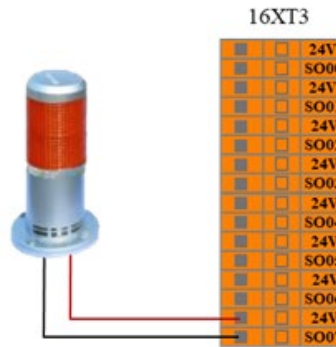

Figure 8-23 AUBOPE operation indication output connection mode

8.5 Internal I/O

The internal IO of the control box are internal function ports, which provide I/O state display of the internal interface board of the controller. This part of the ports is not open to user. The user can monitor the internal I/O state through AUBOPE software (see 10.3.1Controller I/O). The internal IO state of the control box is described in the following table:

Table 8-4 Internal IO name and functions

Input	Function
CI00	Enable status – Linkage mode / Disable status – Manual mode
CI01	Enable status – Host / Disable status – Slave
CI02	Power Contactor of Control Box
CI03	Control Box Emergency Stop
CI16	Robot Power On
CI11	Robot Power Off
CI16	Power Contactor of Control Box
CI13	Control Box Emergency Stop
Output	Function
CO00	Stand By
CO01	Emergency Stop
CO02	Enable status – Linkage mode / Disable status – Manual mode
CO03	AUBOPE Running
CO10	Back Up
CO11	Emergency Stop
CO12	Back Up
CO13	Back Up

8.6 General I/O

The AUBO interface board has 16 digital input interfaces, 16 digital output interfaces, 4 pairs of analog differential input interfaces, 2 pairs of analog voltage output interfaces and 2 pairs of analog current output interfaces which electrical errors are about $\pm 1\%$.

The following table lists the function's definitions of the various I/O. Users must follow the requirements in the table. In addition, users should note that buttons and switches on control panel occupy part of the I/O.



When connecting external devices, all external devices should be connected to the ground with the control box.

8.6.1 General Purpose Digital I/O Interface

The general-purpose digital I/O interface is located on the upper interface panel of the control box.

There are 16 general purpose digital input ports ("DI terminal" will be represented as the digital input port) on the panel; they all work in the NPN mode, which means when DI terminal and the ground is connected, it can trigger action; but when the DI terminal disconnected with the ground, it does not trigger any action.

The DI terminal can read the action signals from switch buttons, sensors, PLC or other AUBO robots.

There are 16 general purpose digital output ports ("DO terminal" will be represented as the digital input port) on the panel; they all work in the NPN mode. The working process of DO terminal can be expressed as the following figure. When logic "1" is given, DO terminal and GND are connected; when a logic "0" is given, DO terminal and GND are disconnected.

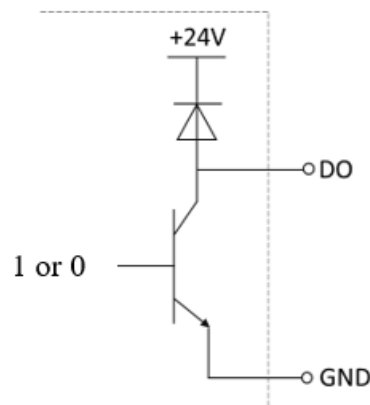

Figure 8-24 DO connect GND

The DO terminal can be directly connected to load or can communicate with PLC or other robots. The user can control the above digital IO through AUBOPE software.

Table 8-5 General-purpose digital I/O interface list

I/O Type	IO Name							
	Input	DI00	DI01	DI02	DI03	DI04	DI05	DI06
DI16		DI11	DI16	DI13	DI14	DI15	DI16	DI17
Output	DO00	DO01	DO02	DO03	DO04	DO05	DO06	DO07
	DO10	DO11	DO12	DO13	DO14	DO15	DO16	DO17

Table 8-6 General-purpose digital I/O interface electrical parameter specification

I/O Type	Parameter	Specification
DI	Input signal form	P-lesend No-voltage contact input NPN open collector transistor
	Input method	Input signal current
	Electrical specifications	5mA / DC24V
DO	Output form	Transistor (P-lesend type)
	Electrical specifications	300mA / DC24V

Table 8-7 General-purpose digital Input port electrical parameter specification

Parameter Term	Minimum Value	Maximum Value
Single DI input voltage	0 V	24 V

Example:

Some common wiring examples are listed below.

DI terminal connection button switch

As shown in the figure below, the DI terminal can be connected to ground (G) through a normally open button. When the button is pressed, the DI terminal and GND are turned on to trigger an action. When the button is not pressed, the DI terminal is disconnected from GND, and no action is triggered. This is the simplest wiring example.

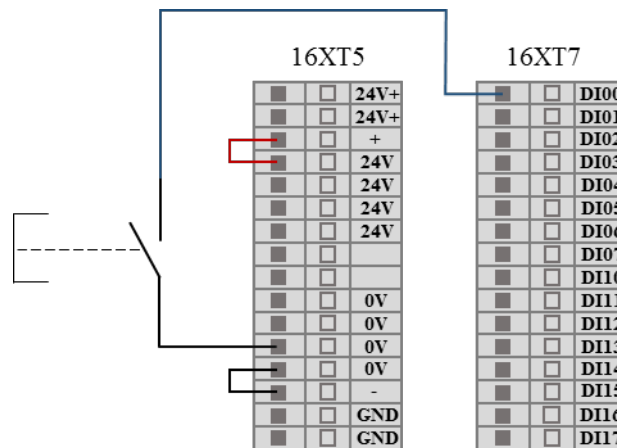

Figure 8-25 DI terminal connection button switch schematic

DI terminal connection two-end sensor

As shown in the figure below, there is a sensor connected between the DI terminal and GND. When the sensor is working, even if the voltage difference between the OUT terminal and the GND terminal is small, the action can be triggered. When the sensor is not working, the loop is disconnected, and the action is not triggered.

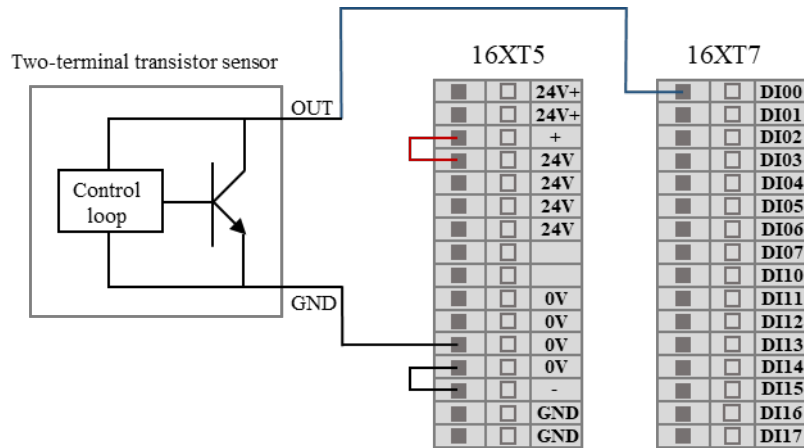

Figure 8-26 DI connect to two-terminal sensor

DO terminal connect external load

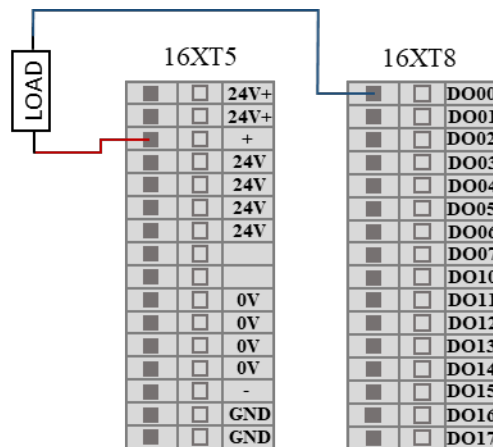

Figure 8-27 DO terminal connect external load

8.6.2 Analog I/O Interface

The analog I/O interface is located on the interface board on the upper panel of the control box. There are 4 pairs of analog voltage input interfaces, indicated by VI. There are 2 analog voltage outputs and 2 analog current outputs, which are represented by VO and CO respectively. As shown below:

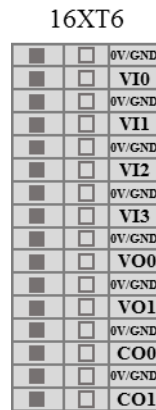

Figure 8-28 Analog I/O interface diagram

Table 8-8 General purpose analog I/O list

I/O Type	I/O Name			
	Input	VI0	Analog voltage input	VI2
VI1		Analog voltage input	VI3	Analog voltage input
Output	VO0	Analog voltage output	CO0	Analog current output
	VO1	Analog voltage output	CO1	Analog current output

Table 8-9 General purpose analog I/O interface electrical parameter specification

Type	Voltage	Current
Input	0 ~ +10V	-
Output	0 ~ +10V	0 ~ 20mA
Accuracy	±1%	±1%

Table 8-10 VI terminal electrical parameters

Parameter term	Minimum value	Maximum value	Units
Input Voltage	0	+10	V
Input Resistance	100K		Ω
VI Sampling Resolution	12		BITS
VI Sampling Accuracy	10		BITS

Table 8-11 VO terminal electrical parameters

Parameter term	Minimum value	Maximum value	Units
Single VO Terminal Output Voltage	0	+10	V
Single CO Terminal Output Current	0	20	mA

Example:

Analog voltage input wiring method

For the analog voltage input, please refer to the wiring method shown below:

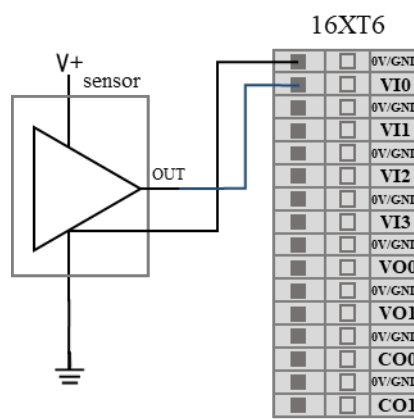

Figure 8-29 Analog voltage input connect to sensor

Analog voltage output wiring method

For the analog voltage output, please refer to the wiring method shown below:

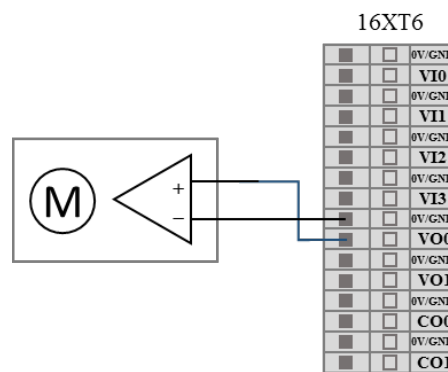

Figure 8-30 Analog voltage output connect drive device

Analog current output wiring method

The analog current output can be wired as shown below:

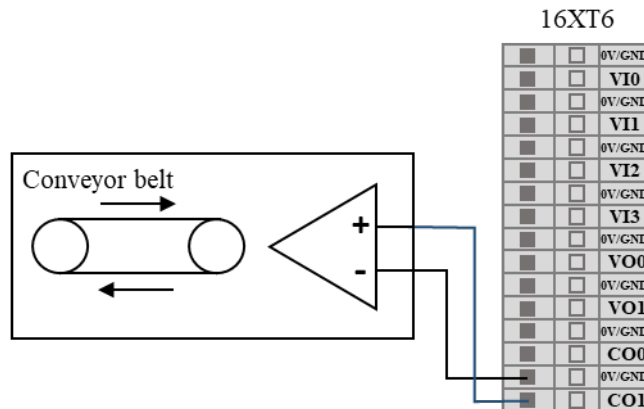

Figure 8-31 Analog current output connect to current source

8.6.3 Clear Alarm Signal Interface

F6 on the upper panel of the control box is used as “warning/error message clearing input port.”. This port is active low.

8.7 Remote Switch Control I/O Interface

The remote power on/off control I/O interface is located on the upper panel of the control box.

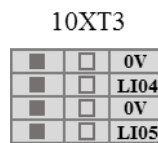

Figure 8-32 Remote control I/O interface

The remote power on/off control I/O interface allows user to control the teach pendant and robot to be turned on or off without pressing the real bottom at the teach pendant.

Table 8-12 Remote Switch Control I/O Interface

Input	Functional description
LI04	Remote system startup signal input port
LI05	Remote system shutdown signal input port

8.7.1 Remote Power On

This example shows how to connect the remote start up port, when the switch is closed, the teach pendant and the robot will be powered up automatically (Note: When conduct this step, the "Standby" light at the control box must on).

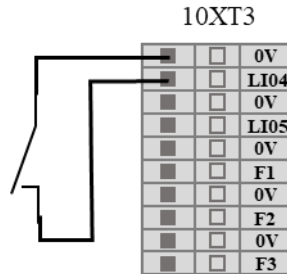

Figure 8-33 Remote start up connection

8.7.2 Remote Power Off

This example shows how to connect the remote shutdown port, when the switch is closed, the teach pendant and the robot will start power off process and shut down finally.

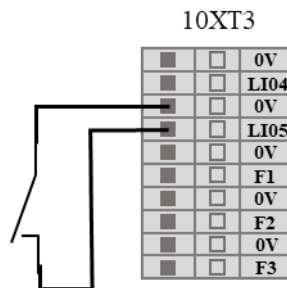

Figure 8-34 Remote shutdown connection

8.8 Linkage Control I/O Interface

The linkage control I/O interface is located on the upper panel of the control box and is represented by LI/LO, as shown in the figure below.

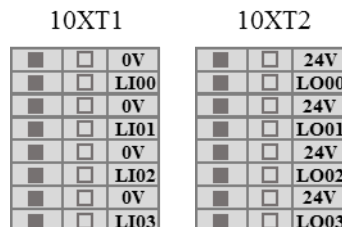

Figure 8-35 Linkage control I/O interface

The linkage control interface can be used to control the movement of robot without the teach pendant. For details on the usage, see 7.4.2 Linkage mode.

8.9 Robot Tool I/O Interface

There is an 8-pins mini connector on the tool end, to provide power and control signals to specific tools (Holder, etc) used in the end. Its electrical error is about $\pm 10\%$. Wiring as shown below.

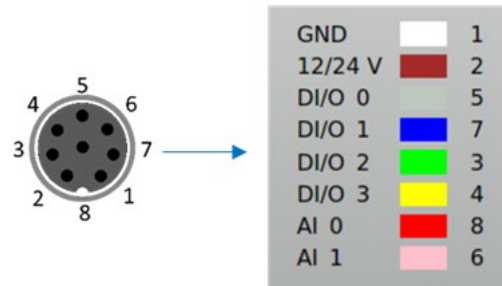

Figure 8-36 Robot Tool I/O wiring order

Tool I/O interface pin functions

The eight pins inside the tool I/O interface used industrial cable with different colors. The different colors designate different functions, see the table below:

Table 8-13 Tool I/O interface pin function list

Pin	Color	Signal
1	White	GND
2	Brown	12/24V
5	Gray	DI/O 0
7	Blue	DI/O 1
3	Green	DI/O 2
4	Yellow	DI/O 3
8	Red	AI 0
6	Pink	AI 1

Tool I/O interface analog port electrical parameters

Table 8-14 Tool I/O interface analog port electrical parameters

Parameter item	Min	Max
Voltage input analog AI 0	0V	+10 V
Voltage input analog AI 1	0V	+10 V

Tool I/O interface power supply electrical parameters

In the "Settings" tab of AUBOPE software, the user could set the tool I/O power supply (PIN 2) to 0V, 12V or 24V. The electrical specifications are list as follows.

Table 8-15 Electrical parameters in different modes of power supply

Parameter	Min	Typ	Max	Unit
Supply voltage in 24V mode	23	24	25	V
Supply voltage in 12V mode	11.5	12	12.5	V
Supply current in two modes	-	0.8	1.0	A

Tool I/O interface digital output

The digital output is in NPN form. After the digital output is activated, the corresponding connector will be driven to GND. After the digital output is disabled, the corresponding connector will be disconnected. The electrical specifications are as follows:

Table 8-16 Tool I/O interface digital output electrical parameters

Parameter	Min	Typ	Max	Unit
Voltage at open circuit	Same supply voltage			
Voltage when inputting 1A current	0.35	0.4	0.85	V
Input Current	0.35	0.4	0.5	A
Current through GND	0.35	0.4	0.5	A

Tool I/O interface digital input

The digital input is implemented as an NPN with a weak pull-down resistor as shown in the following figure:

Table 8-17 Tool I/O interface digital input electrical parameters

Parameter	Min	Typ	Max	Unit
Input voltage	-0.5	-	Vout+2	V
Logic low voltage	0	1.5	2	V
Logic high voltage	Vout-4	Vout	Vout+2	V
Input resistance	-	4.3	-	kΩ

Tool I/O interface other electrical parameters

Table 8-18 Tool I/O interface other electrical parameters

Parameter	Min	Typ	Max	Unit
Input voltage in voltage mode	0	-	10	V
Input resistance resolution in 0V to 10V voltage range	-	2.5	-	mV



When connecting the tool and the holder, please ensure that there is no danger when interrupting the power supply, such as dropping the workpiece from the tool.

9. Getting Started

9.1 Basic Function Introduction

The robot body is an execution part of the robot system, wherein the base is for mounting the robot body, the shoulder and the elbow perform a large amplitude action, the wrist 1 and the wrist 2 perform a finer motion, and the wrist 3 can connect tools.

The control box is the control part of the robot system, which can control the movement position, posture and trajectory of the robot in its workspace; it also provides electrical input and output terminals for external electrical device.

The teach pendant is the display and operation part of the robot system. It has a human-computer interaction interface that could provide menu operation, programming and online operation. The user can directly operate AUBOPE software and control the robot to perform related tasks through the the teach pendant.



DANGER!

Make sure that the control box, teach pendant, and cables are not contact with liquids. A wet control box can cause casualty.



CAUTION

Before taking out AUBO robot from the packing box and conducting installation, please read the specific installation instructions in chapter 6: Installation.



CAUTION

1. Control box should be placed horizontally on the ground. A gap of 50mm on each side is needed for sufficient air circulation.
2. The teach pendant can be hung on the control box. Make sure that no one can step on the cable.

9.2 Robot System Installation

Install the robot body and control box (see Chapter6 Robot Installation, for specific installation instructions and warning information) before using AUBOPE. Please refer to the following procedure to install the robot system.

1. Unpacking the robot body, control box, teach pendant, and related cables.
2. Mount the robot body to a strong, shock-resistant surface.
3. Put the control box in the proper position.
4. Connect the cable to the corresponding robot body, control box and teach pendant. (Please refer to 6.6 Cable connection for specific connection instructions and warning information.
5. It is determined that the safety information in Chapter 6 ROBOT INSTALLATION has been observed and the warning information has been circumvented.
6. Plug in the power plug of the control box power socket.

9.3 Power on the Robot System

9.3.1 Preparation before Power up

1. Check the connection of the manipulator and the control box.
2. Check the connection of the teach pendant and the control box.
3. Check the connection of the power cable and the control box.
4. Check whether the power switch of the control box is shutdown when robot is unpowered.
5. Check whether the emergency stop button on the control box and the teach pendant is pop-up.
6. Check whether the mode switch key is in right position.
7. Ensure the robot never hit any personnel or equipment.

9.3.2 Power on the Robot System

1. Power on the control box

Connect the control box power cable connector to the AC power outlet, then turn the power from OFF to ON, then the "POWER" indicator on the control box front panel will on.

2. Power on the teach pendant and the manipulator

- a) Select the working mode with the MODE MANUAL/LINKAGE button (Robot has two working modes: manual mode and linkage mode. Please refer to Chapter 7.4 for more instructions).
- b) Wait for the "STANDBY" indicator on the control box front panel to light up.
- c) Press the power button on the upper left of the teach pendant for about 1s until blue light appears. The teach pendant will start and the screen of teach pendant will light up.

The power button and LED indicator are as shown in the figure below:



Figure 9-1 Teach pendant and the power button



During the process of power-on and brake release of the manipulator, do not interfere with the robot externally, such as disassembling and assembling tool grippers, shaking the robot, etc.

9.4 Power Off the Robot System

The order of system power off: First, power off the manipulator and the teach pendant, then power off the control box.

1. Power off the manipulator and the teach pendant:

Normal shutdown process: Exit the AUBOPE software by click the power button at the top robot corner of the screen , the software, the manipulator and the teach pendant will shutdown automatically.

Mandatory shutdown: press and hold the power button on the upper left of the teach pendant for about 3s. Then the blue light will off, the teach pendant and the manipulator will power off.

2. Power off the control box:

Turn the power switch of the control box to OFF position.



1. Unplugging the power cable connector directly from the AC outlet to shut down the system may result in damage to the robotic file system, which may result in robot malfunction.
2. Ensure to unplug the power cable after powering off the whole robot system!

9.5 Start System Quick

Before starting the robot system, please make sure the manipulator and control box are installed correctly.

1. Turn the control box power switch to the ON state, wait for the power indicator and standby indicator to light up.
2. Press the switch button on the teach pendant to start AUBOPE, and the text will be displayed on the interface.
3. A pop-up window appears on the touch screen to indicate that the system enters the initialization interface.
4. Select and determine the tool.
5. Please stand outside the reach of the robot body (work space).
6. Click the start button to release the robot brake system. At this time, the robot body vibrates and clicks, indicating that the robot system has been started and enters the state to be programmed.

10. Teach Pendant

10.1 Introduction

The teach pendant is an important component of AUBO robot. Users can acquire information of the manipulator through the teach pendant, User also can control the manipulator to move and perform simple programming through the teach pendant.



Figure 10-1 Overview of the teach pendant

Table 10-1 Teach pendant components and functions

NO.	Name	Function
1	Power switch	Used to power on or off the teach pendant.
2	LCD touch screen	Display of robot operation and status information.
3	Emergency stop button	The emergency stop button on the teach pendant can be used to stop the robot. To reset the button, the user needs to rotate the button.
4	Teach pendant cable	Connect to the control box.
5	USB	Used for program upgrades, file copying, log copying, etc.
6	Force control switch	It is a three-position enabling switch that can realize the three-position action of avoiding dangerous OFF (opening) ⇒ ON ⇒ OFF (pressing). When the switch is in the ON state, the robot can be dragged to teach.
7	Pencil	Used for touch operation of the teach pendant interface.

10.2 AUBOPE Software Operation Interface

10.2.1 User Login

After the Teach Pendant powered on, a user disclaimer window pops out (the user can tick the option to no longer prompt, and then run the AUBOPE software will no longer appear in this interface). After clicking through, a user login window will pop up.

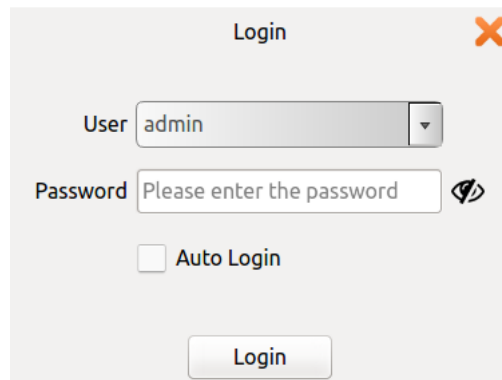

Figure 10-2 login interface

The user needs to select an account, enters a password before login.

Table 10-2 User Classification

User	Password	Permission limit
Admin (administrator)	Initial password: "1", modifiable	Highest authority, unlimited
Operator	Initial password: "1", modifiable	Safety settings (10.5) and update (10.6.6) are unavailable
Default (default user, cannot choose actively)	Default password: "1", unmodifiable	Safety Settings (10.5) and update (10.6.6) are unavailable

- Username does not support customization.
- After checking the automatic login, the software will automatically enter the selected user interface after it is turned on again.
- To cancel automatic login or switch user login, you need to click the logout icon in the upper right corner of the interface.
- After determining the logout operation, if there is a running project, it will stop running and switch to the user login interface.
- In the linkage mode, you are advised to select the login user and check the automatic login option. If it is not checked, the default user is entered.

10.2.2 Initialization Window

After starting the AUBOPE, the following window will pop up:

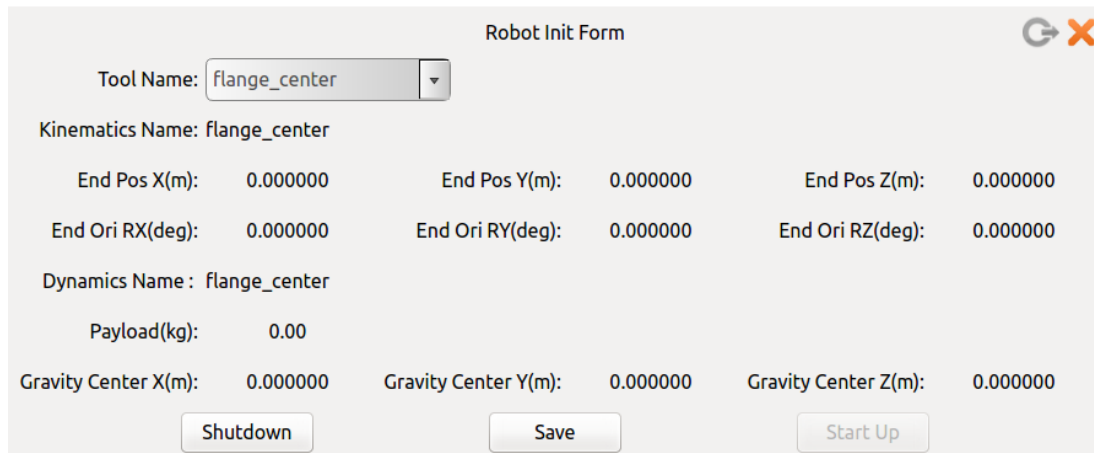

The image shows a 'Robot Init Form' window with the following fields and values:

Field	Value
Tool Name	flange_center
Kinematics Name	flange_center
End Pos X(m)	0.000000
End Pos Y(m)	0.000000
End Pos Z(m)	0.000000
End Ori RX(deg)	0.000000
End Ori RY(deg)	0.000000
End Ori RZ(deg)	0.000000
Dynamics Name	flange_center
Payload(kg)	0.00
Gravity Center X(m)	0.000000
Gravity Center Y(m)	0.000000
Gravity Center Z(m)	0.000000

Buttons: Shutdown, Save, Start Up

Figure 10-3 Initial Interface

User can select the specified tool configurations. This configuration is introduced in Chapter 10.4.2.

Click **“save”** -> **“start up”** button, then the robot starts initialization and powers up.



The Tool Name must be consistent with the load installed on the real manipulator. If it is inconsistent, the manipulator may be abnormal.

10.2.3 Robot Movement Control

Robot Teaching Interface

The AUBOPE software is used for the robot teaching operation. User can move the robot by clicking icon on the panel and get feedback information of its movements from the certain panel. This section mainly focuses on the Robot Teaching Interface.

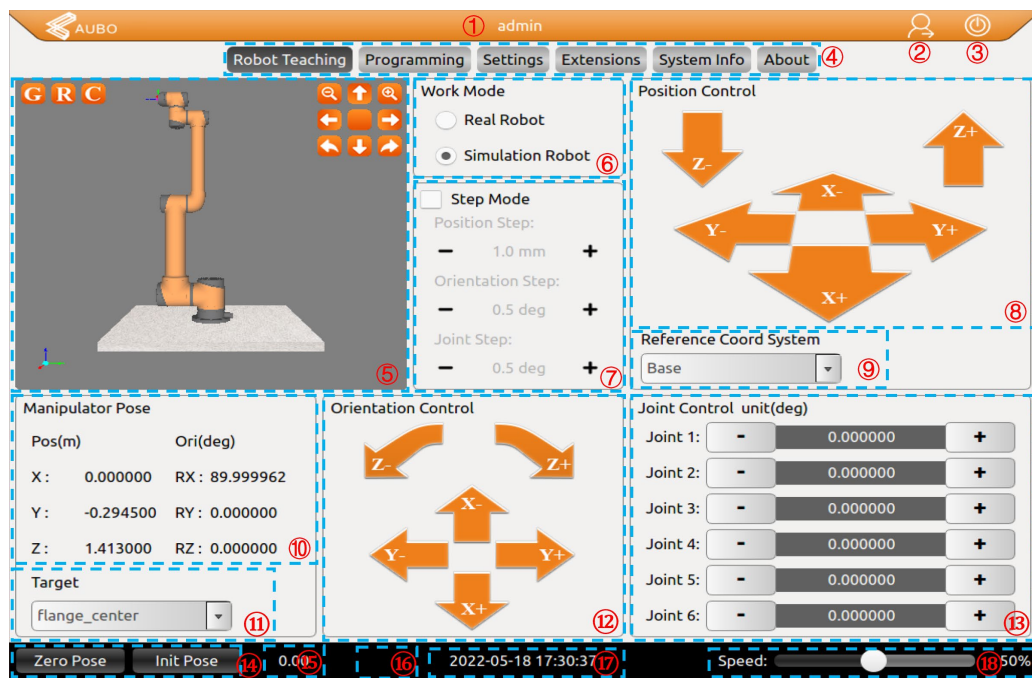

Figure 10-4 Robot Teaching interface

Table 10-3 The Robot Teaching Interface

NO.	Name
1	User type
2	Logout button
3	Software shutdown button
4	Menu bar
5	3D simulation window (Only in simulation mode)
6	Work mode selection
7	Step (Jog) settings
8	Position control panel
9	Reference coordinate system selection
10	Target position and orientation status
11	Target selection

NO.	Name
12	Orientation control
13	Single joint control
14	Zero pose and initial pose button
15	TCP speed display
16	Collision level display
17	Date and time display
18	Robot teaching mode overall speed control

1. Current user type

The header bar displays the type of the currently logged in user. You can use the logout button to switch user type. For details, see 10.2.1 User login.

2. Logout button

The user can logout by clicking this button .

3. Software shutdown button

The user can shutdown the software and the robot by clicking this button .

4. Menu bar

The user can click certain tag at the menu bar switch different interfaces. The selected tag will have a color reverse on its text and background.

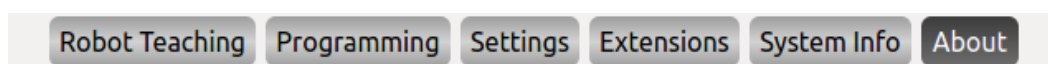

Figure 10-5 Menu bar

5. Robot 3D simulation window

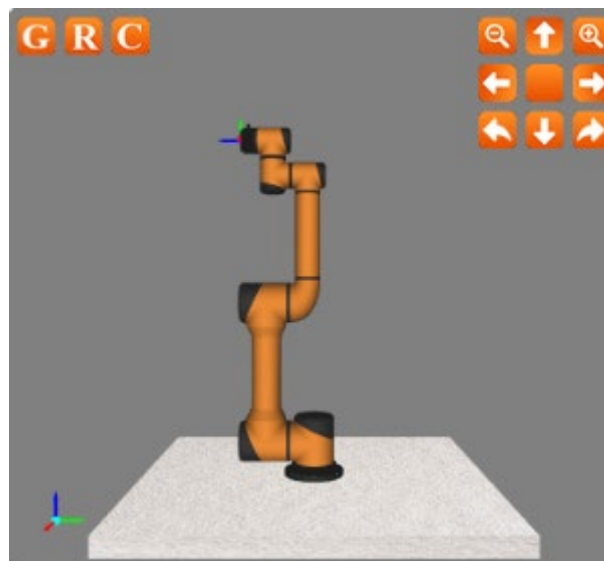















Figure 10-6 Robot 3D simulation window

Robot 3D simulation verifies the user-written project without using the real robot. The simulation model can also be used to validate control programs before applying it on the real robot.

➤ The function of the icons as follow:

	Base plane, click to hide the base reference plane in the simulation interface
	Actual waypoint model, click to hide
	User coordinate, click to hide
	Target waypoint model, click to hide
	Zoom out button
	Zoom in button
	Pan up button
	Pan down button
	Pan left button
	Pan right button
	Turn clockwise

	Turn counterclockwise
	Reset button

6. Simulation/real control switch button

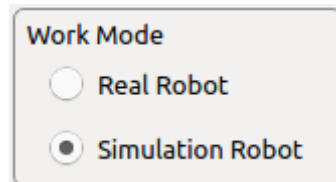

Figure 10-7 Robot mode selection.

- When "Real Robot" is selected, the teach pendant/AUBOPE will control the robot in real time. At this time, the "robot 3D simulation window" will ONLY display robot actual parameters.
- When "Simulation Robot" is selected, the 3D manipulator model operates but the real robot will not move. To verify a program with simulation robot, the user can test whether the program runs according to the requirements. It is an important step to improve the safety of the robot and the user.

7. Step (Jog) settings

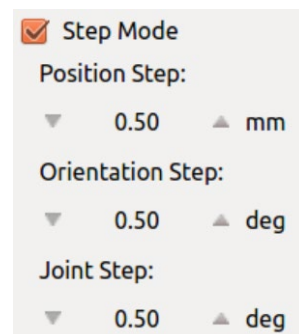

Figure 10-8 Step (jog) settings

To improve the control accuracy and flexibility, it is necessary to increase the step mode control to allow the controlled variable change precisely in a stepwise manner.

- Use step control mode by activating step mode.
- Click the button on both sides of input box to adjust the robot's step length.
- Position step indicates the step length of the end position movement. Unit: mm, range: 0.1-10.00 mm
- Orientation step indicates the step length of the end pose movement. Unit: deg, range: 0.1-10.00 deg
- Joint Step indicates the step length of the joint movement angle. Unit: deg, range: 0.1-10.00 deg
- Step mode control is valid to control the TCP and joints position/orientation only.

8. Position control

The end of manipulator is based on the base coordinate system, the end coordinate system or the user-defined coordinate system to control robot movements. The end of manipulator can teach under different coordinate systems.

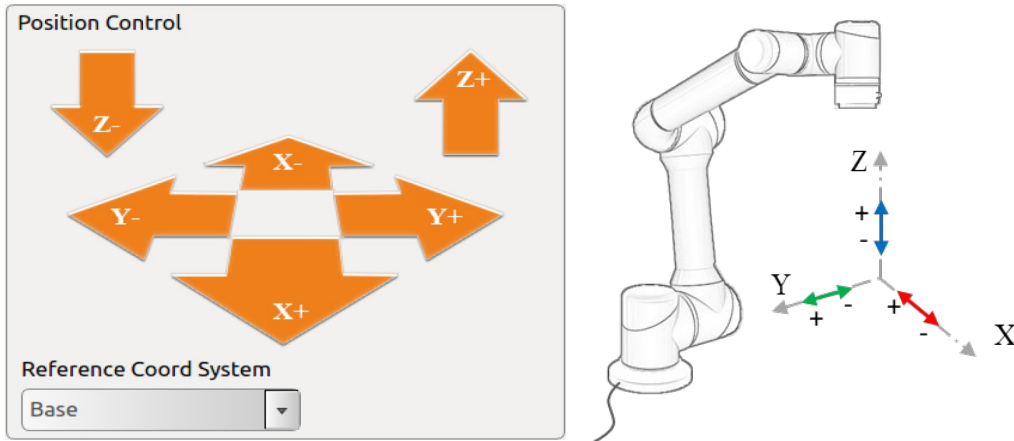

Figure 10-9 Position control (base)

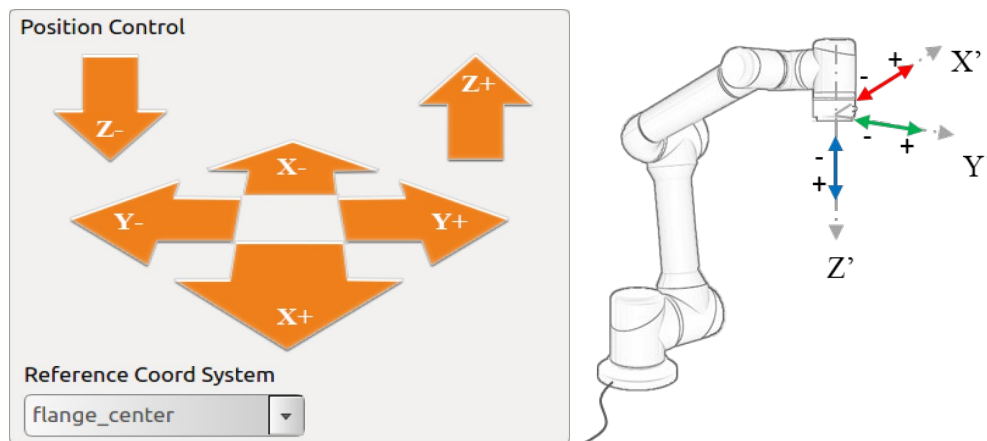

Figure 10-10 Position control (Flange center)

9. Coordinate system

The user can control the motion state of the robot based on the base coordinate system, the end coordinate system, and the user-defined coordinate system. It can be set in 10.6.5 that after the robot system is restarted, the selected coordinate system will remain displayed.

a) base

Select the base coordinate system (base) to control the robot on the teach pendant interface, and the robot will move according to the coordinate system as shown below.

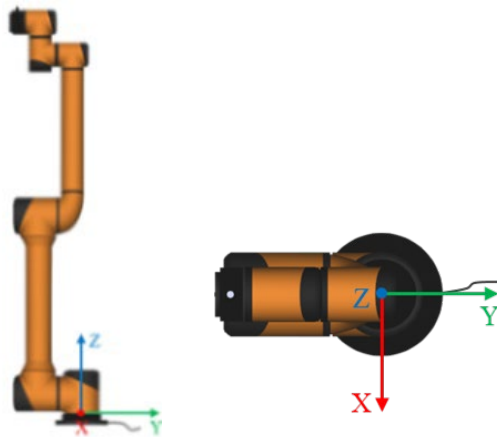

Figure 10-11 base

b) end

Select the end coordinate system (flange_center) on the teach pendant interface to control the robot. The robot will move according to the coordinate system as shown below.



Figure 10-12 Flange center

c) User-defined coordinate system

The user-defined coordinate system requires the user to set the coordinate system details according to the actual situation. For details, please refer to the 10.4.3 coordinate system calibration section. After the setting is completed, the coordinate system name can be selected through the drop-down menu of the teach pendant interface.

10. Target position and orientation status display

Manipulator Pose	
Pos(m):	Ori(deg.):
X: 0.000000	RX: 89.999962
Y: -0.215500	RY: 0.000000
Z: 0.985000	RZ: 0.000000

Figure 10-13 Target position and orientation status

The position X, Y, Z represent the target coordinates under selected coordinate system

The orientation RX, RY, RZ represent the target angle value under selected coordinate system.

Please refer to the 10.4.3 coordinate system calibration section to learn more about coordinate settings.

11. Target selection

The Target Selection drop-down menu provides the option to select the flange center (default) or the specified tool. Users can modify the target via the 10.4.2 Tools Calibration section.

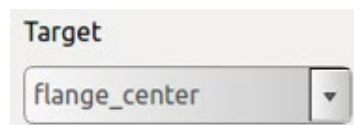

Figure 10-14 Target selection

12. Orientation Control

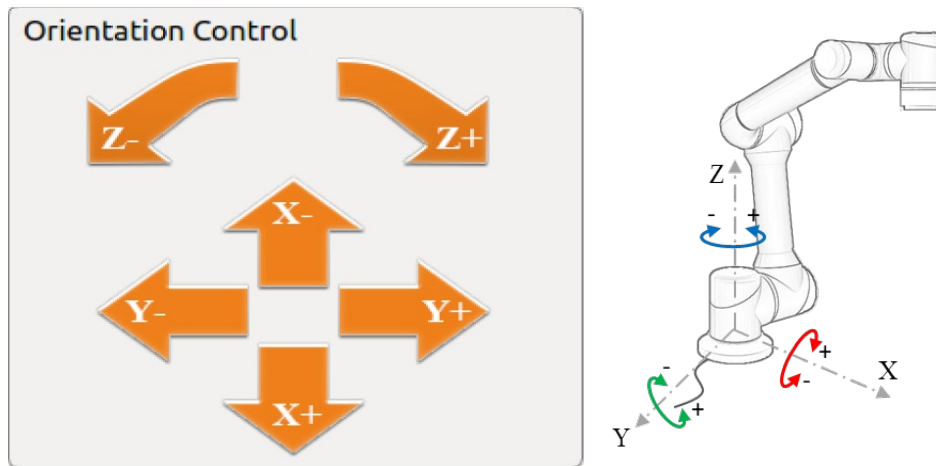

Figure 10-15 Orientation Control (base)

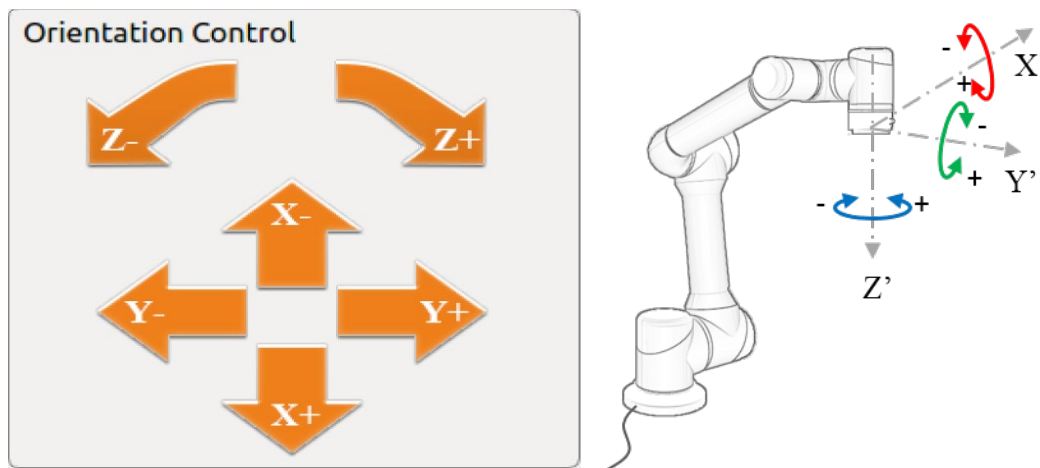

Figure 10-16 Orientation Control (Flange center)

13. Single joint control

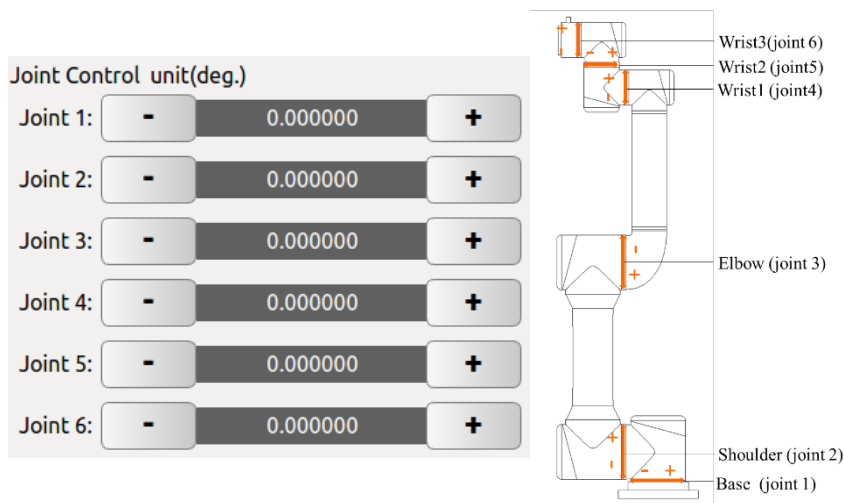

Figure 10-17 Illustration of joint control.

- The robot has six degrees of freedom, its joints are named "Joint 1" to "Joint 6" from base to top. The user can control the movement of each joint by operating the single joint control panel.
- "+" represents that a joint motor rotates counterclockwise; "-" represents that a joint motor rotates clockwise, as shown above.
- After the robot is powered on again, the color of the joint angle value will be different, and the color will return to normal after moving more than 5°.
- Unit: degree.

14. Zero pose and initial pose button



Figure 10-18 Buttons of Zero Pose and Init Pose

- **Zero Pose:** Press and hold the button can move the robot back to the zero position
- **Init Pose:** Press and hold the button can move the robot back to the initial pose. Users can set arbitrary initial pose in **"Settings"** -> **"Robot"** -> **"InitPose"** in AUBOPE software.

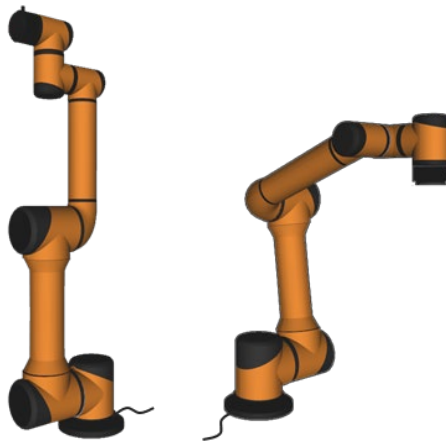

Figure 10-119 Zero Pose and Init Pose(default)

15. TCP speed display

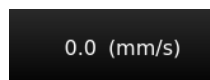

Figure 10-20 TCP speed display

Here shows the TCP actual speed during robot movements.

16. Collision level display

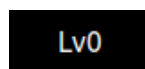

Figure 10-21 Collision display

Here shows the robot's current collision level. The user could change the collision level in "Settings" interface.

17. Date and time display



Figure 10-22 Date and Time display

Here shows current date and time, which can be set by referring to chapter 10.6.2 Date Time Settings section.

18. Robot teaching mode overall speed control



Figure 10-23 Robot teaching mode overall speed control

The user can adjust overall speed (in percentage) of the robot in teaching mode.

But when the robot moves according to programs, this speed control will not be active.

10.3 Robot I/O Settings and State Display

The electrical I/O of the robot system (see chapter 8 Electrical Interface) can be viewed and configured with the following description. The I/O settings interface is divided into controller I/O settings, user I/O settings, and tool I/O settings.

10.3.1 Controller I/O Panel

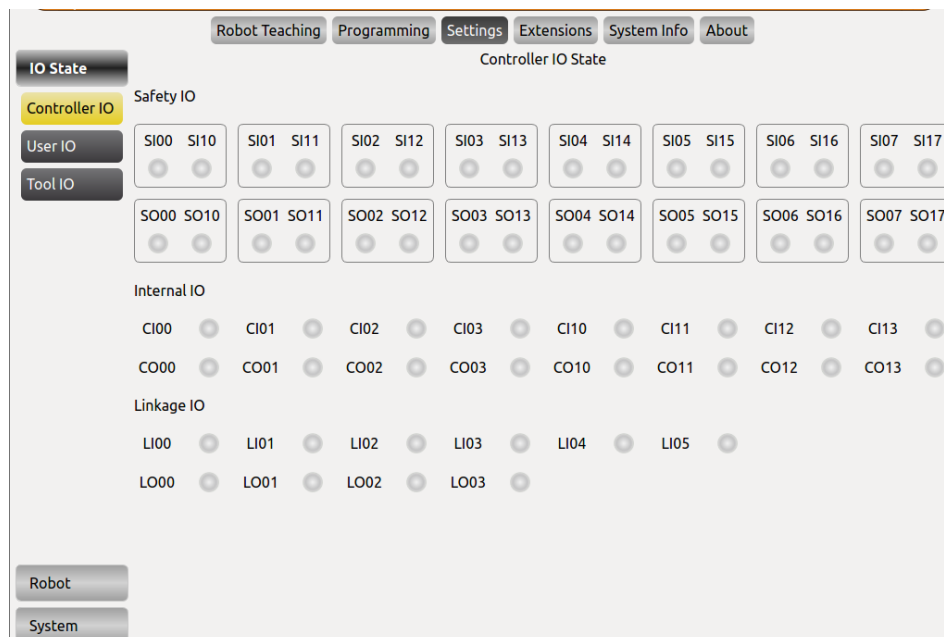

Figure 10-24 Controller I/O panel

- Safety I/O: the safety I/O are designed as dual channel (redundant design) to ensure the safety function should not be lost in any case of single failure.
- Internal I/O provides state display of the internal I/O, which are not available for user.
- Linkage I/O displays linkage I/O state.

10.3.2 User I/O Panel

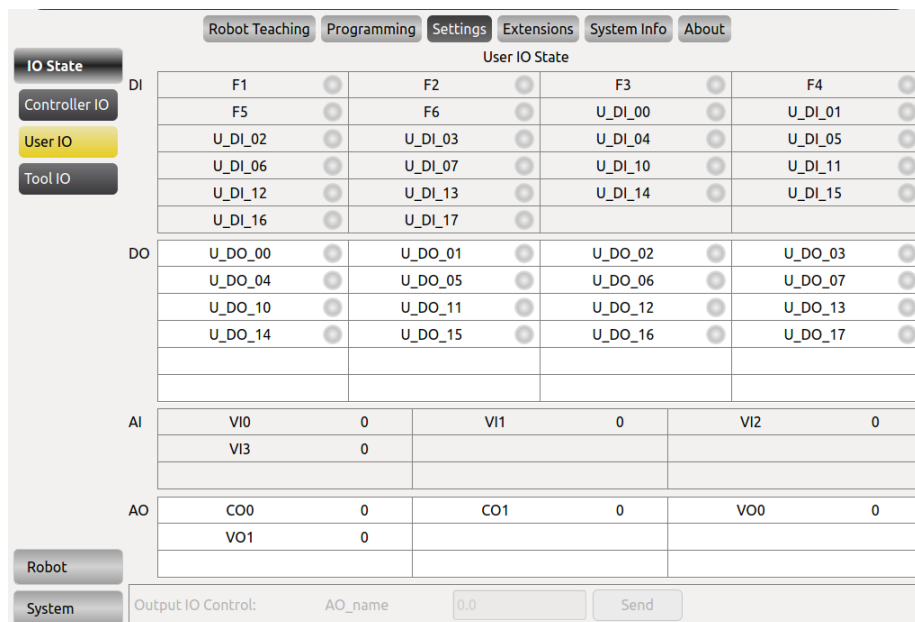

Figure 10-25 User I/O Panel

- DI and DO are general digital I/O with a total of 16 inputs and 16 outputs that can be used for direct drive relays and other electrical equipment.
- F1-F5: Reserved IO ports, currently unavailable.
- F6: Warning/error message clearing input, active low.
- Analog input is used to display the voltage of the external sensor. There are 4 analog input signals: VI0, VI1, VI2 and VI3, the range is 0V ~ +10V, and the accuracy is $\pm 1\%$.
- Analog output is used to display the voltage / current value of the output of the interface board. There are four analog output signals: VO0, VO1, CO0 and CO1, respectively VO0, VO1 output voltage, CO0, CO1 output current.
- Output IO control: select the IO, and then enter the corresponding value in the text box, where DO have 0 and 1 two states, AO: the voltage output range of 0V ~ +10 V, the current output range of 0mA ~ 20mA (recommended input 4mA ~ 20mA current value), click "Send" button, the corresponding IO is set to the default value.

10.3.3 Tool I/O Panel

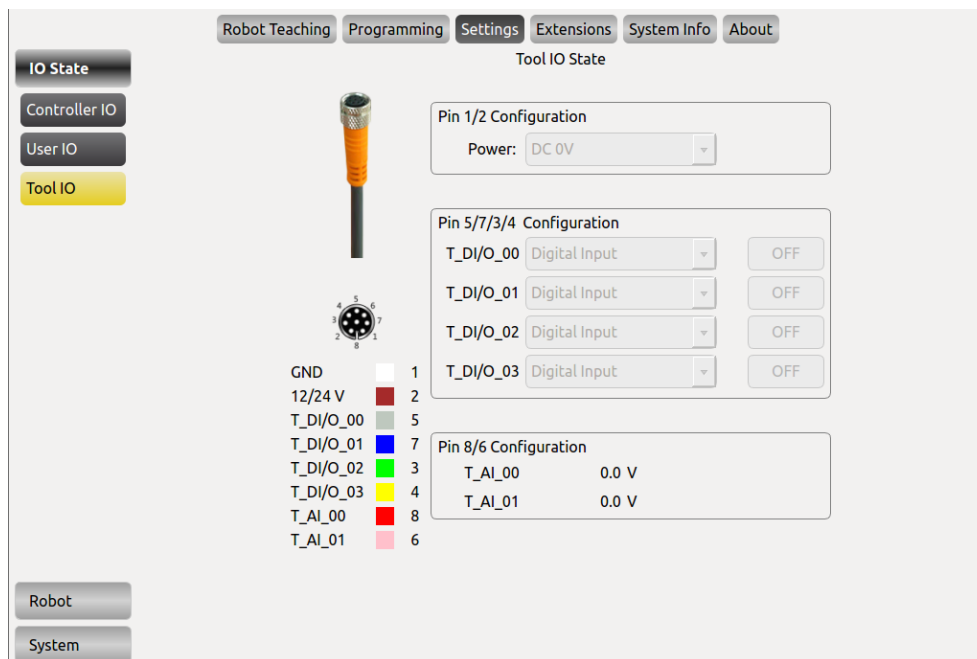

Figure 10-26 Tool I/O panel

- Tool I/O Tab: It is the display of end-effect's setting state. Users can configure 4 digital I / O by pin 3/4/5/7, and pin 6/8 can be configured as an analog input. Pin 2 can be configured to three kinds of output voltages: 0v, 12V and 24V.
- Users need to configure the voltage of pin 2 and states of pin 3/4/5/7 based on the actual usage before using this function.

10.4 Settings Interface

10.4.1 Pose Setting

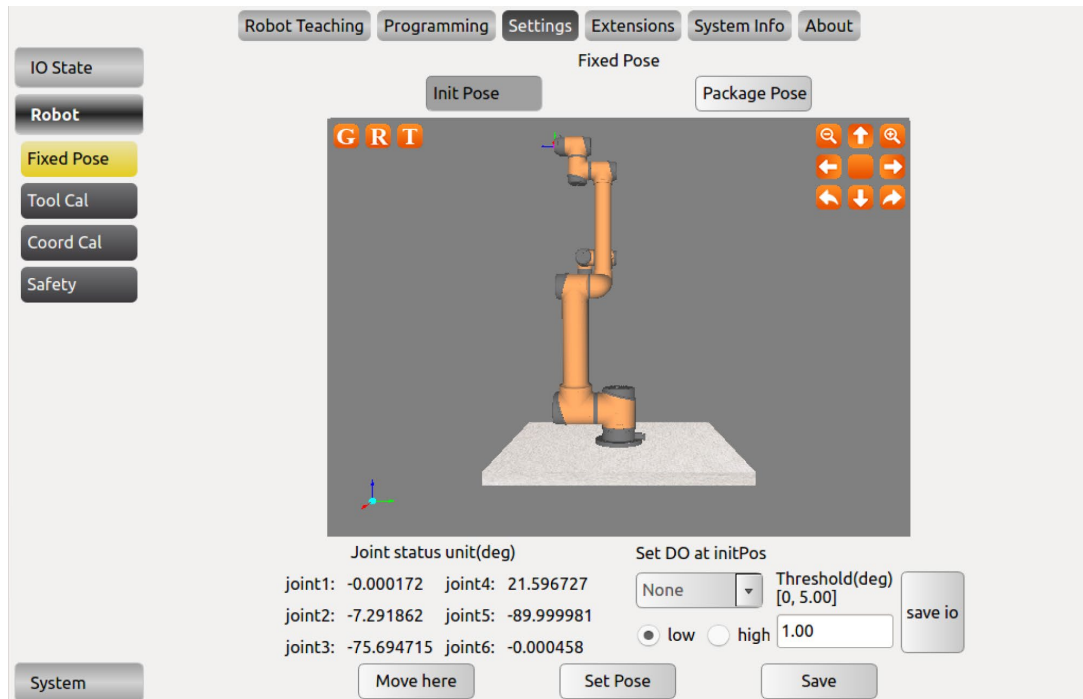

Figure 10-27 Init Pose

Set initial pose:

- Click "Init Pose" under "Fixed Pose" panel.
- Click "Set Pose" to set the initial position by moving robot via the position control panel or hand guiding.
- Click "Save" to set current pose as initial pose.

Set package pose:

- Click "Package Pose" under "Fixed Pose" panel.
- Click "Set Pose" to set the initial position by moving robot via the position control panel or hand guiding.
- Click "Save" to set current pose as initial pose.

Set DO at initPos:

- Select a DO under "Set DO at initPos".
- Check "high" and click "Save". After the robot moves to the initial position, the selected DO will have a signal output.
- Enter the Threshold and click "Save". The set DO when it reaches the initial position will output a signal according to the set threshold.

10.4.2 Tool Calibration

The screenshot shows the 'Tool Calibration' interface. At the top, there are tabs for 'Robot Teaching', 'Programming', 'Settings', 'Extensions', 'System Info', and 'About'. Under 'Settings', there are sub-tabs for 'Tool Cal', 'Kinematics Cal', and 'Dynamics Cal'. On the left, there is a vertical menu with buttons for 'IO State', 'Robot', 'Init Pose', 'Tool Cal' (highlighted in yellow), 'Coord Cal', and 'Safety'. At the bottom left is a 'System' button.

Tool Name	Kinematics Name	Dynamics Name
flange_center	flange_center	flange_center

Below the table, the configuration panel for the selected tool 'flange_center' is shown:

- Tool Name:
- Kinematics Name:
- End Pos X(m): 0.000000 End Pos Y(m): 0.000000 End Pos Z(m): 0.000000
- End Ori RX(deg): 0.000000 End Ori RY(deg): 0.000000 End Ori RZ(deg): 0.000000
- Dynamics Name:
- Payload(kg): 0.00
- Gravity Center X(m): 0.000000 Gravity Center Y(m): 0.000000 Gravity Center Z(m): 0.000000

At the bottom, there are buttons for 'Add', 'Modify', and 'Delete'.

Figure 10-28 Tool Calibration

Tool calibration consists of two parts: kinematics calibration and dynamics calibration. A tool consists of kinematic properties (kinematic parameters that constrain tool end trajectory) and dynamics properties (Constraints on the dynamics, such as speed and acceleration, of a manipulator with a load).

The tool calibration in the above figure is divided into three calibration panels: Tool Calibrate, Kinematics Calibrate and Dynamics Calibrate.

After calibrating the kinematic and dynamic parameters of the tool, enter the tool calibration panel, select a kinematic and dynamics attribute for the tool, enter a name for the tool, and then add tools.

The meaning of the symbols involved in the interface:

- The subscripts 't' and 'b' respectively represent the tool coordinate system and the base coordinate system.
- F, X, Y and Z respectively represent the coordinate system, X axis, Y axis and Z axis.

The steps to calibrate a tool are as follows:

- Kinematics calibration: determine tool parameters.
- Kinematics parameter setup: parameters can be calibrated through kinematics or can also be set by the user.
- Dynamics calibration: determine load and tool center of gravity parameters.
- Tool calibration.

1. Tool Kinematics Calibration

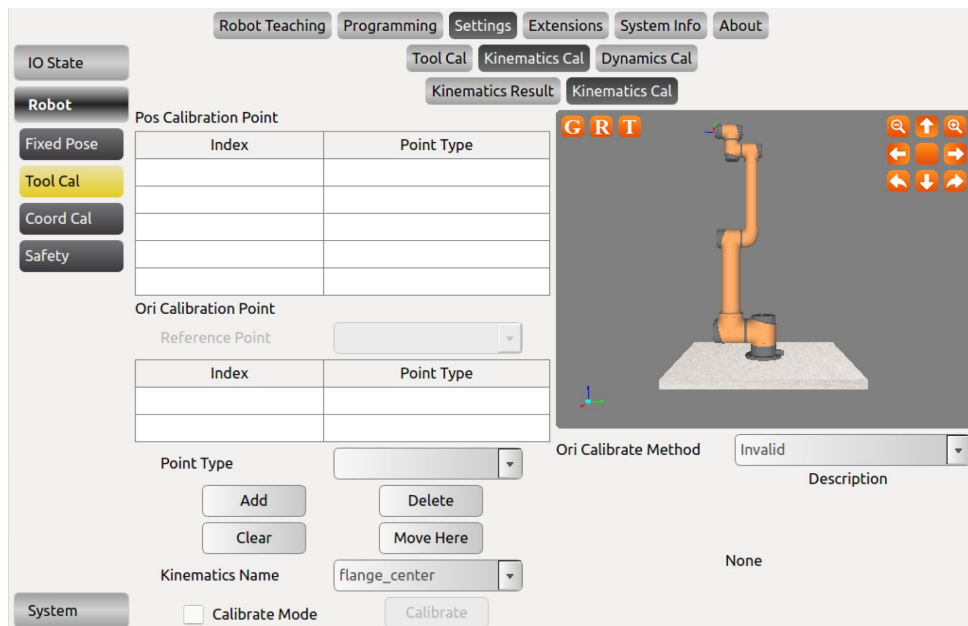

Figure 10-29 Tool Kinematics Calibration

The tool kinematics calibration panel consists of two parts: position calibration and orientation calibration.

Before tool kinematics parameter calibration, please ensure the tool has been mounted to the manipulator. Please first setup position calibration points, then setup orientation calibration points

The position and orientation calibration steps are as follow:

- Go to the kinematics calibration page as figure 10-29.
- Position calibration: select point type as "Pos Calibration", click "Add", enters robot teaching interface, control robot to move to certain point. Click "Confirm" button at the lower right corner of the screen. A position reference point is set. (4 points are required for position calibration.)
- Orientation calibration: We take "xOxy" reference method as an example. Select "xOxy" at Ori Calibration Method, select any position point at "reference point" menu, select point type as "Ori Calibration". Click "Add", enters robot teaching interface, control robot to move to certain point. Click "Confirm" button at the lower right corner of the screen. An orientation reference point is set (2 points are required for orientation calibration).
- Click to enable "Calibration Mode", then click "Calibration". The display will jump to "Kinematics result" page. Then, input a tool kinematics name, click "Add". Meanwhile, this page supports manually input tool kinematic parameters.

2. Position Calibration:

Position calibration requires at least 4 waypoints to determine the parameters.

Note: Position calibration is required for tool kinematics calibration, there is only one method: setup 4 or more points while the reference point (the end tool relative to the coordinate system of the base) position unchanged. Ideally the flange centers of all reference points are on the surface of a sphere whose center is at the end of the real tool.

3. Orientation Calibration

The orientation calibration only needs two points (exclude the reference point).

Orientation calibration is optional, by default the tool's pose is the same as the flange centers. According to the need of reference position (any points of the 4+ position reference point), the ori-calibration can be divided into two categories, a total of six calibration methods:

Category 1 – Calibration with reference points: It includes xOxy, yOyz, zOzx methods. We take "xOxy" reference method as an example, the reference point is the origin of the tool end coordinate system; The ray formed by the origin and the first orientation point is the X_t positive semi-axis; The vector formed by the origin and the second orientation point is in the xOy plane, and the angle between the vector and the positive semi-axis of Y_t is an acute angle (Try not to make the angle close to 90 degrees)

Category 2 – Calibration without reference point: It includes "TxRBz_TxyPBzAndTyABnz", "TyRBz_TyzPBzAndTzABnz" and "TzRBz_TzxPBzAndTxABnz" methods. The difference in point orientation from category 1 calibration method is that: the positive semi-axis of one axis of the tool end coordinate system must be parallel to Z_t ; the difference in operation from category 1 calibration method is that: no need to select reference point (the reference point menu is disabled)

The requirement of six calibration methods is:

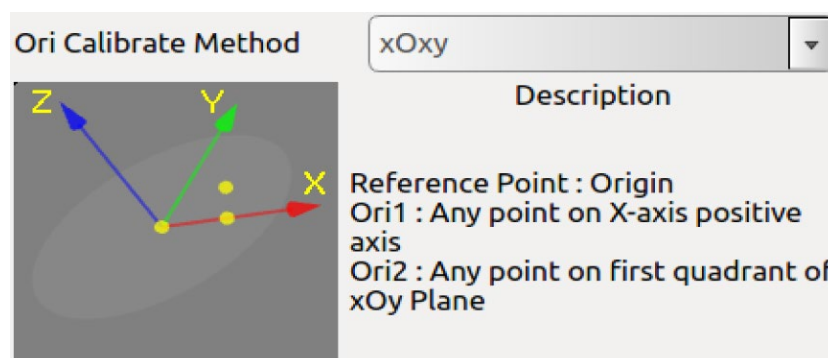

Figure 10-30 xOxy type calibration method

The figure above is xOxy type calibration method, the reference point is the origin; the first point to be calibrated is any point on the positive semi-axis of X_t , and the second point to be calibrated is any point in the first quadrant of the xOy plane of F_t .

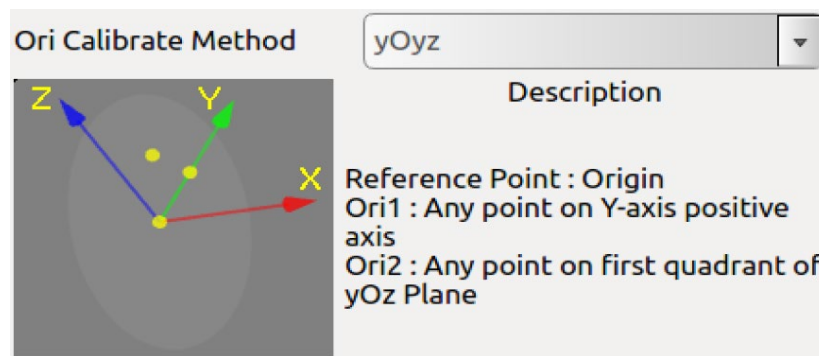

Figure 10-31 yOyz type calibration method

The figure above is yOyz type calibration method, the reference point is the origin; the first point to be calibrated is any point on the positive semi-axis of Yt, and the second point to be calibrated is any point in the first quadrant of the yOz plane of Ft.

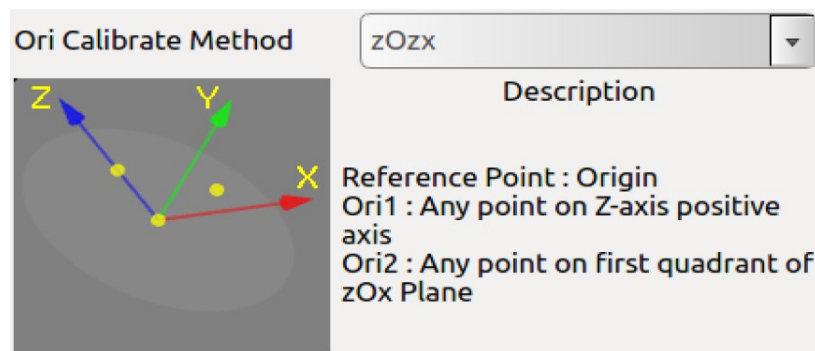

Figure 10-32 zOzx type calibration method

The figure above is zOzx type calibration method, the reference point is the origin; the first point to be calibrated is any point on the positive semi-axis of Zt, and the second point to be calibrated is any point in the first quadrant of the zOx plane of Ft.

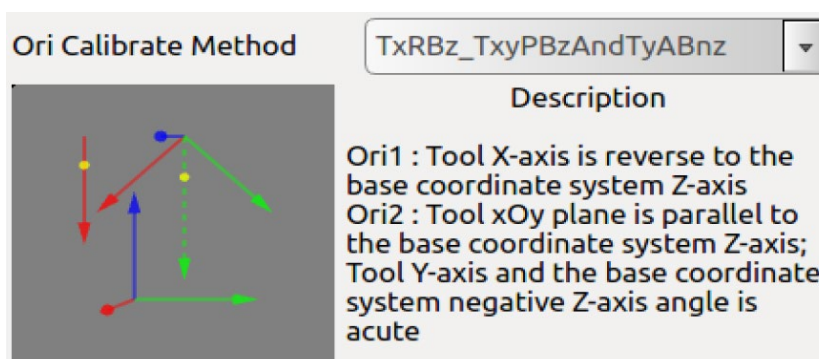

Figure 10-33 TxRBz_TxyPBzAndTyABnz type calibration method

The figure above is TxRBz_TxyPBzAndTyABnz type calibration method. The first calibrated point satisfies Xt and Zb parallel, but the direction is opposite; the second calibrated point satisfies Ft and the xOy plane is parallel to Zb, and the projection of the negative Zb vector on the xOy plane of Ft and Yt is an acute angle.

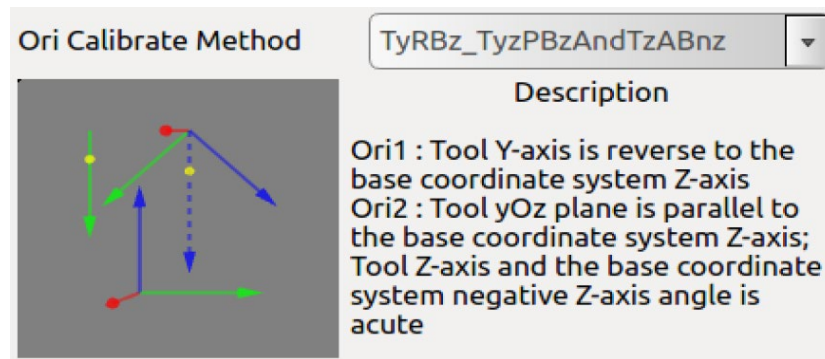

Figure 10-34 TyRBz_TyzPBzAndTzABnz type calibration method

The figure above is TyRBz_TyzPBzAndTzABnz type calibration method. The first calibrated point satisfies Yt and Zb parallel, but the direction is opposite; the second calibrated point satisfies Ft and the yOz plane is parallel to Zb, and the projection of the negative Zb vector on the yOz plane of Ft and Zt is an acute angle.

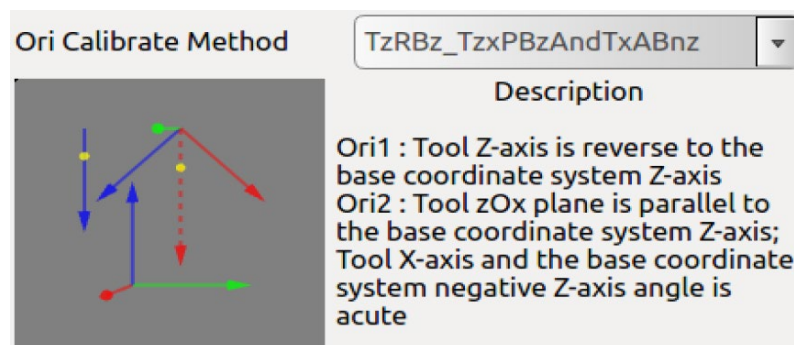
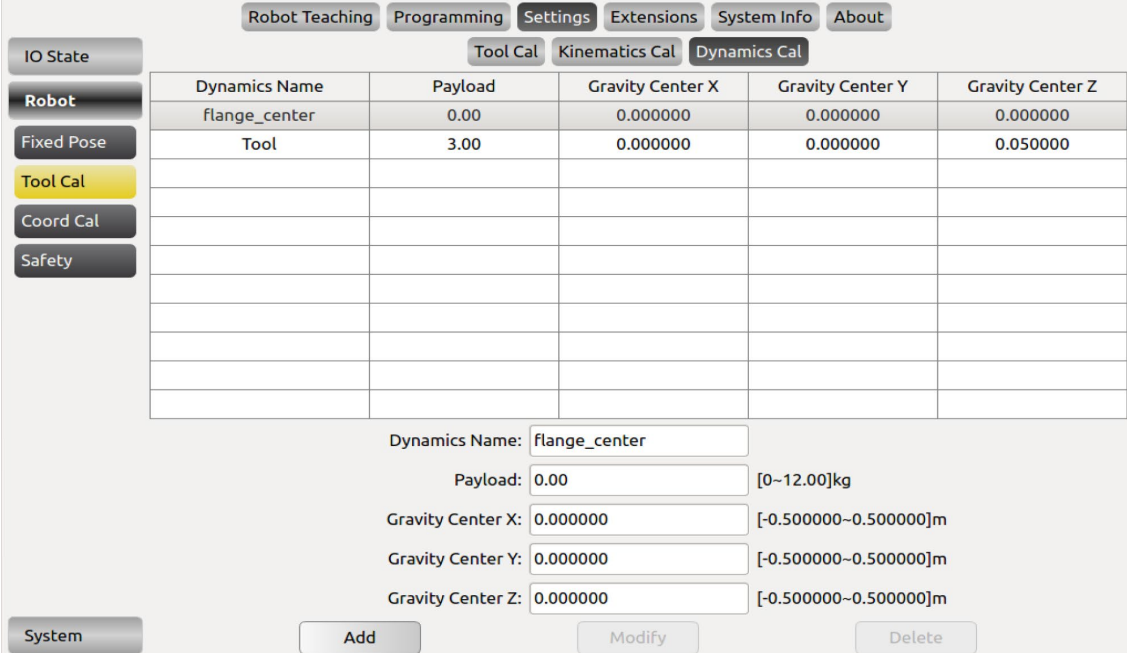

Figure 10-35 TzRBz_TzxPBzAndTxABnz type calibration method

The figure above is TzRBz_TzxPBzAndTxABnz type calibration method. The first calibrated point satisfies Zt and Zb parallel but the direction is opposite; the second calibrated point satisfies Ft and the zOx plane is parallel to Zb, and the projection of the negative Zb vector on the zOx plane of Ft and Xt is an acute angle.

5. Tool Dynamics Calibration



Dynamics Name	Payload	Gravity Center X	Gravity Center Y	Gravity Center Z
flange_center	0.00	0.000000	0.000000	0.000000
Tool	3.00	0.000000	0.000000	0.050000

Dynamics Name:

Payload: [0~12.00]kg

Gravity Center X: [-0.500000~0.500000]m

Gravity Center Y: [-0.500000~0.500000]m

Gravity Center Z: [-0.500000~0.500000]m

Figure 10-37 Tool Dynamics Calibration

- The picture above shows the tool dynamic calibration interface. enter the load, the tool center of gravity parameters and tool name and click **"Add"** to save the parameters.
- When modifying the tool dynamics parameters, first, select the item to be modified, and then, enter the value to be modified, and click **"Modify"** to complete the modification.
- When deleting the tool dynamic parameters, first select the item to be modified, and then click the **Delete** button to delete.

Note: "flange_center" is the system default parameter, which can not be modified and deleted.



It may cause different malfunctions if setting data is inaccurate in the actual operation. If the setting is wrong, the manipulator and the control box cannot work normally and can cause danger to personnel or equipment around.

6. Tool Calibration

Tool Name	Kinematics Name	Dynamics Name
flange_center	flange_center	flange_center

Tool Name :
 Kinematics Name :
 End Pos X(m): 0.000000 End Pos Y(m): 0.000000 End Pos Z(m): 0.000000
 End Ori RX(deg): 0.000000 End Ori RY(deg): 0.000000 End Ori RZ(deg): 0.000000
 Dynamics Name :
 Payload(kg): 0.00
 Gravity Center X(m): 0.000000 Gravity Center Y(m): 0.000000 Gravity Center Z(m): 0.000000

Figure 10-38 Tool Calibrate

- The picture above is the tool calibration interface. After completing the tool kinematics and the dynamic parameters calibration, please follow the following steps: enter the interface, select the tool kinematics and dynamics parameters from the drop-down list, enter the tool name, and click **"Add"** button to save the tool parameters.
- When modify the tool calibration, select the item to be modified, you can modify the name, kinematic parameters, and dynamic parameters. Click **"Modify"** button to complete the modification.
- When delete tool calibration, select the item to be modified and click **"Delete"** button to delete.

Note: "flange_center" is the system default parameter, which can not be modified and deleted.



It may cause different malfunctions if setting data is inaccurate in the actual operation. If the setting is wrong, the manipulator and the control box cannot work normally and can cause danger to personnel or equipment around.

10.4.3 Coordinate System Calibration

1. Coordinate system calibration methods

The picture shows the coordinate system calibration interface, the coordinate system is divided into nine types, namely: xOy, yOz, zOx, xOxy, xOxz, yOyz, yOyx, zOzx, zOzy.

The different coordinate system types' naming rules, calibration points and requirements are listed as follows:

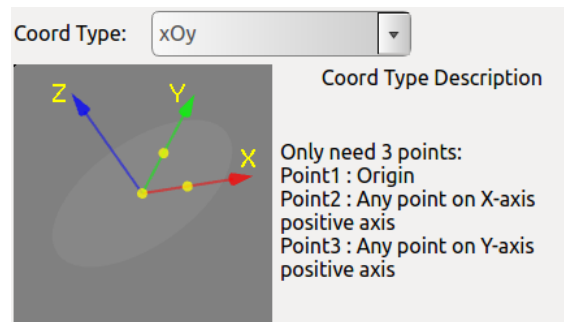

Figure 10-39 xOy

The figure above is xOy type, The first point requires for the calibration is the origin of the coordinate system, The second point is any point on the positive of the X-axis, and the third point is any point on the positive semi-axis of the Y-axis. Taking the first point as the vertex, the angle formed by the three points is a right angle.

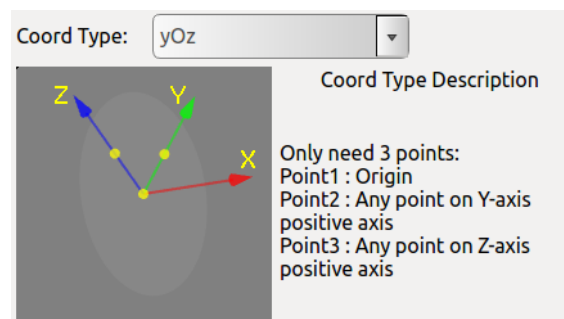

Figure 10-40 yOz

The figure above is yOz type, the first point requires for the calibration is the origin of the coordinate system. The second point is any point on the positive of the Y-axis, and the third point is any point on the positive semi-axis of the Z-axis. Taking the first point as the vertex, the angle formed by the three points is a right angle.

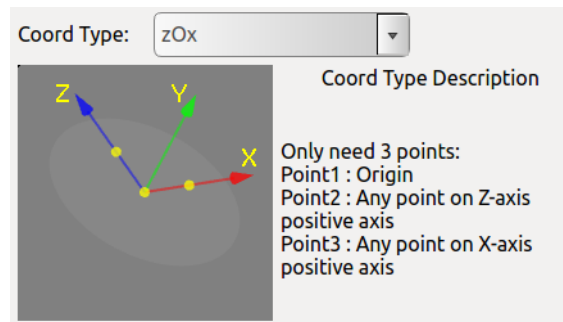

Figure 10-41 zOx

The figure above is zOx type, the first point requires for the calibration is the origin of the coordinate system. The second point is any point on the positive of the Z-axis, and the third point is any point on the positive semi-axis of the X-axis. Taking the first point as the vertex, the angle formed by the three points is a right angle.

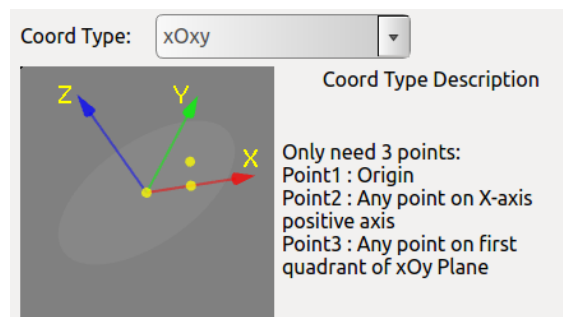

Figure 10-42 xOxy

The figure is xOxy type, The first point requires for the calibration is the origin of the coordinate system, the second point is any point on the positive semi-axis of the X-axis, and the third point is formed at any point within the first quadrant of the xOy plane. The angle formed by the three points is an acute angle.

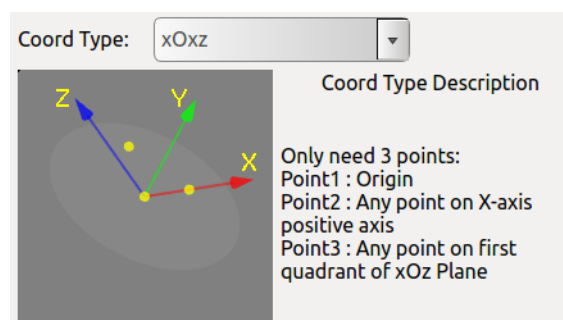

Figure 10-43 xOxz

The figure is xOxz type, The first point requires for the calibration is the origin of the coordinate system, The second point is any point on the positive of the X-axis, and the third point is formed at any point within the first quadrant of the xOz plane. Taking the first point as the vertex, the angle formed by the three points is an acute angle.

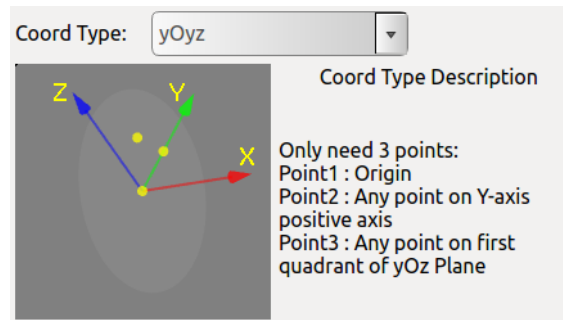

Figure 10-44 yOyz

The figure is yOyz type. The first point requires for the calibration is the origin of the coordinate system. The second point is any point on the positive of the Y-axis, and the third point is formed at any point within the first quadrant of the yOz plane. Taking the first point as the vertex, the angle formed by the three points is an acute angle.

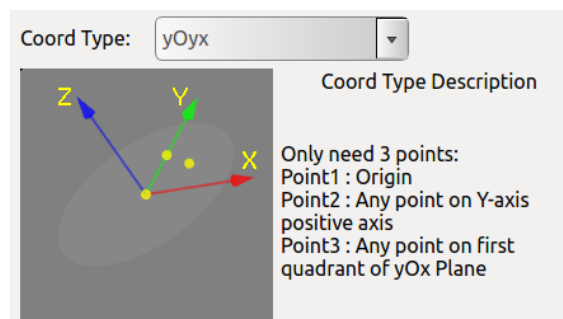

Figure 10-45 yOyx

The figure is yOyx type, The first point requires for the calibration is the origin of the coordinate system. The second point is any point on the positive of the Y-axis, and the third point is formed at any point within the first quadrant of the yOx plane. Taking the first point as the vertex, the angle formed by the three points is an acute angle.

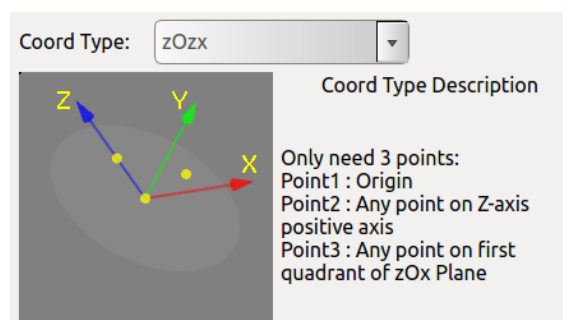

Figure 10-46 zOzx

The figure is zOzx type. The first point requires for the calibration is the origin of the coordinate system. The second point is any point on the positive of the Z-axis, and the third point is formed at any point within the first quadrant of the zOx plane. Taking the first point as the vertex, the angle formed by the three points is an acute angle.

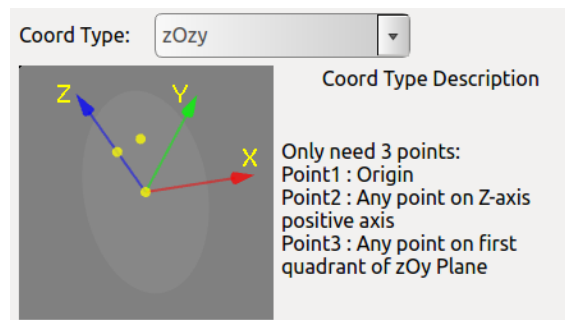

Figure 10-47 zOzy

The figure is zOzy type. The first point requires for the calibration is the origin of the coordinate system. The second point is any point on the positive of the Z-axis, and the third point is formed at any point within the first quadrant of the zOy plane. Taking the first point as the vertex, the angle formed by the three points is an acute angle.

2. Coordinate system calibration steps

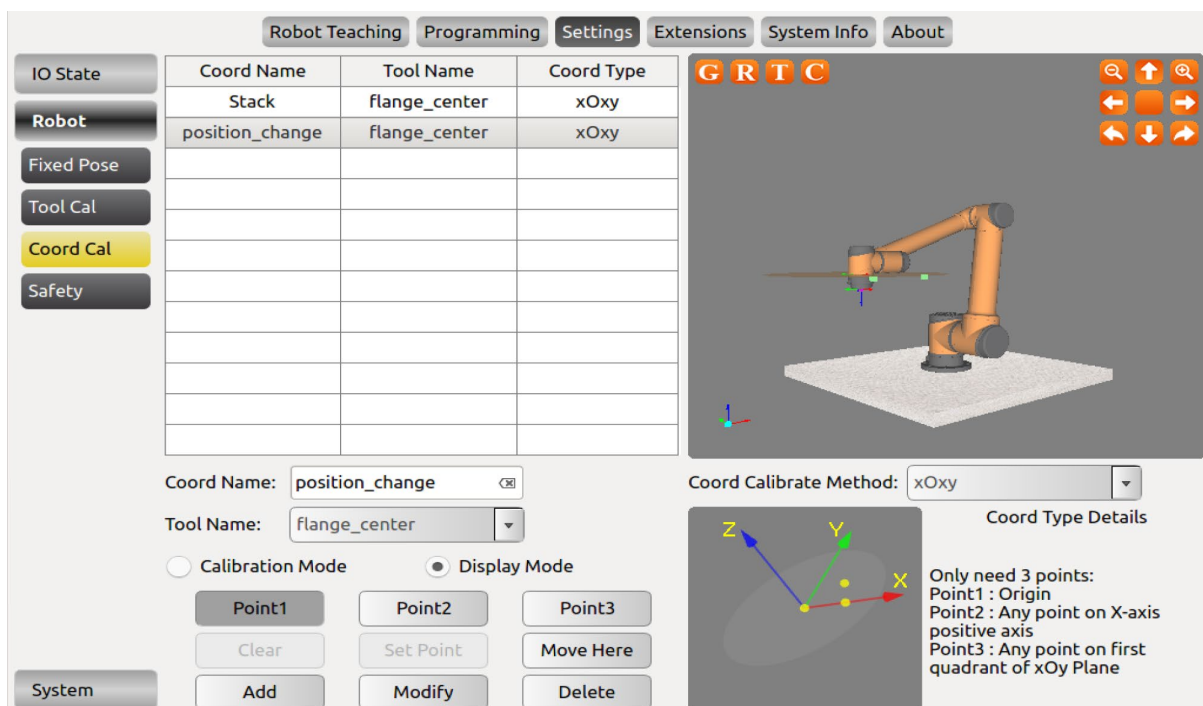

Figure 10-48 Coordinate System Calibration

Before calibration, the user should first determine the coord calibration method. The user can select the desired method through the drop-down menu on the right, named "coord calibration method". Then select Point1, click "Set Point", enter the robot teaching interface, move TCP to the origin of the coordinate system, click "confirm" to set current point. Use the same method to calibrate Point2 and Point3.

Enter the coordinate system name and click "Add" button to save the coordinate system parameters.

- When modifying the coordinate system, first select the coordinate system in the list, click "**Modify**", then you can modify Point1 to Point3.
- The name of the coordinate system can also be modified. After setting, click "**Modify**" button to save the modified parameters.
- When deleting a coordinate system, first select the coordinate system in the list and click "**Delete**" button to remove the coordinate system.
- The function of the "**Clear**" button is to clear the calibration results from Point1 to Point3 under.
- The "**Display Mode**" is to display the values of the three waypoints in the calibrated coordinate system. After selecting a coordinate system in the list, it will automatically enter the display mode. When selecting Point1 to Point3 the simulation window will display the value of three points used when calibrating the coordinate system.
- The function of "**Move Here**" is to move to a certain waypoint. In "**Display Mode**", select any button of Point1 to Point3 and click to move here to move to the waypoint used when calibrating the coordinate system.

10.5 Robot Safety Settings

The security configuration interface can be modified by admin user.

10.5.1 Basic Settings

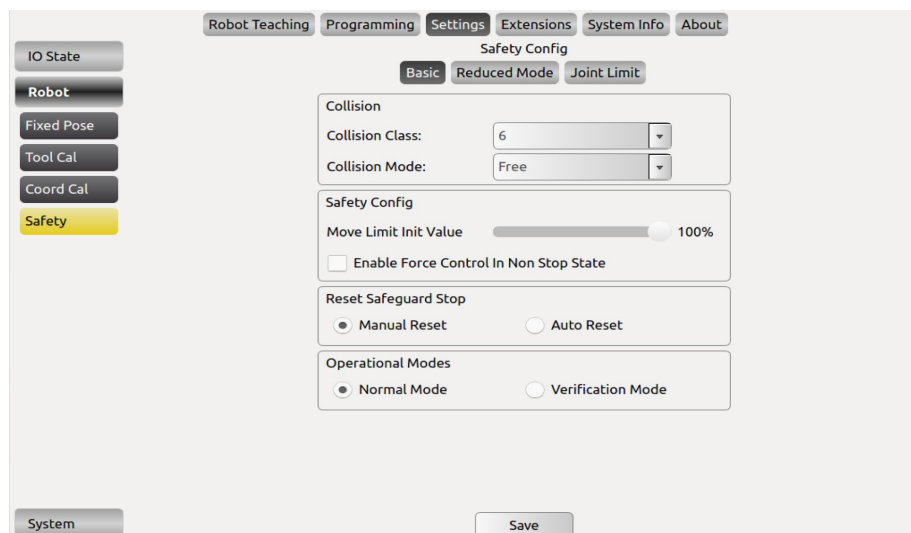

Figure 10-49 Basic Setting

Collision Class

The collision class consist of 1-10 safety levels. The higher the level, the smaller the force required to stop after collision. The 6 level is set to default level.

Collision Mode

Free means that after a collision, the robot will enter the drag teaching mode, and Stuck means that after a collision, the robot will keep its current position and will not be dragged.

Motion limit initial value

The initial value of the motion limit is the limit of the speed of the project. After this configuration is completed, the software will take effect after restarting the software. The motion limit at the online programming interface will be displayed as the setting value here.

Note: This configuration is only valid after restarting the software. The motion limit will be changed after you modify this parameter.

Enable Force Control in Non-Stop State

When enabled, the robot can enter the force control mode through manual signal or external IO (SI06/SI16) after the it is paused, has a collision stop or at safeguard stop status.

Reset Safeguard Stop

When selecting "manual reset", only the external safeguard reset signal can resume the motion after safeguard stop; when selecting "auto reset", the robot will automatically resume motion as soon as the safeguard stop signal becomes invalid, eliminating the need for any external reset signal.

Operational mode

When "Normal mode" is selected, the external enabling device input signal is neglected and thus can not control robot's motion; when "verification mode" is selected, the external enabling device input signal controls the robot's motion. See section 8.4.9 for more information.

10.5.2 Reduced Mode

When this mode is activated, the motion speed of the robot arm in the joint space will be limited. The value in the corresponding text box is the limit value of the motion speed of each joint. The setting range of joints 1, 2, 3 is 1~150 °/s, the setting range of 4, 5, 6 joints is 1~180°/s; the movement speed limit of the robot arm in Cartesian space is the TCP speed limit value, and the setting range is 1~2800mm/s.

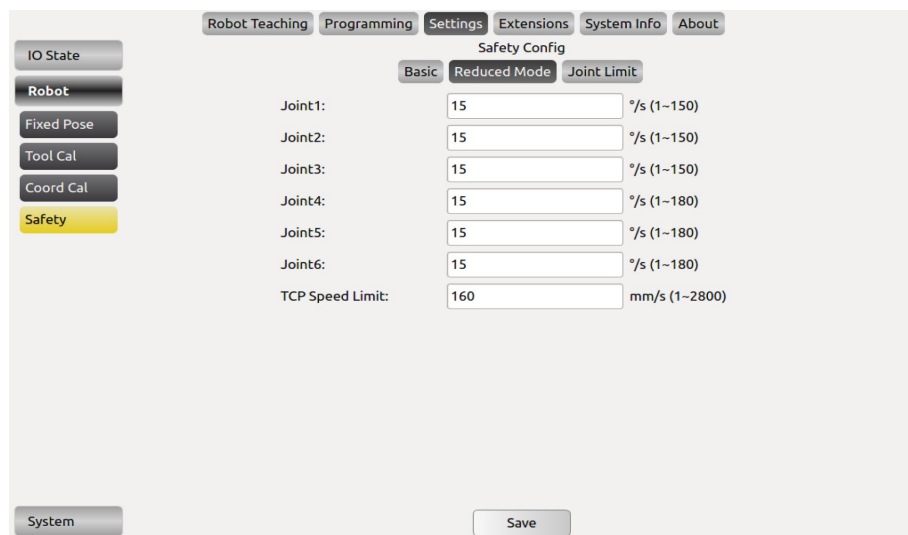

Figure 10-50 Reduced Mode Settings

10.5.3 Joint Limit

When this mode is activated, the motion angle of each joint of the robotic arm will be restricted, and the value in the corresponding text box is the limit value of each joint motion angle. If the set joint angle is exceeded, the robot arm will not move, and a warning message will pop up. Then, if the user needs to move the robot, user needs to use the force control mode to move the robot to the allowable joint angle range.

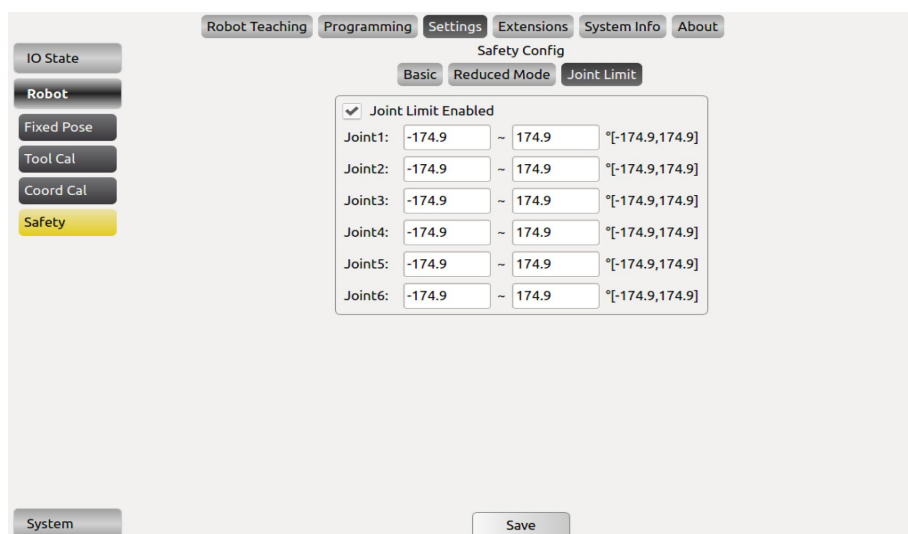

Figure 10-51 Joint Limit Settings

10.6 System Setting Interface

10.6.1 Language Setting

Language page provides English (default), simplified Chinese, traditional Chinese, Czech, German, French, Italian, Japanese and Korean.



Figure 10-52 Language Page

10.6.2 Date & Time Setting

Date& Time page can set date and time.

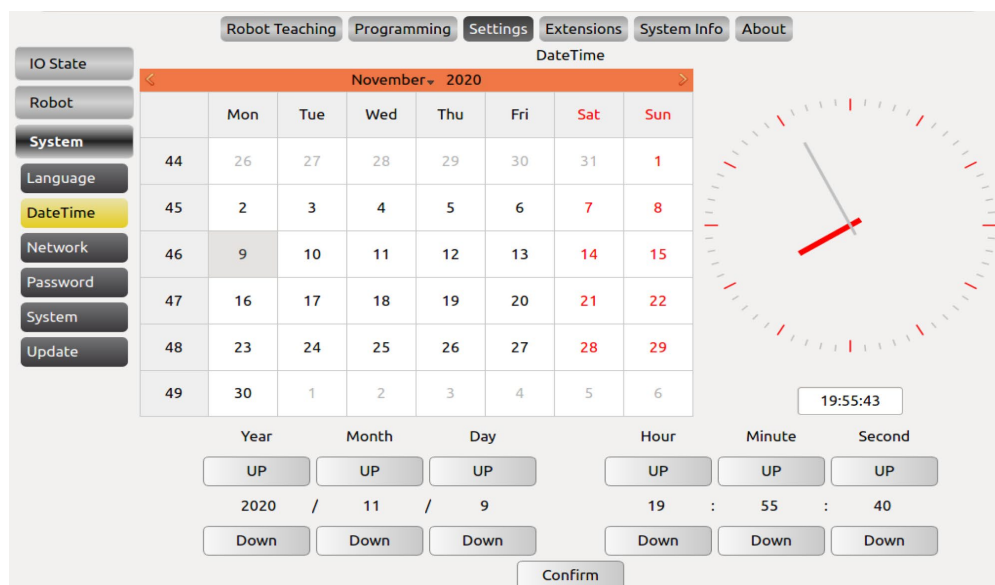

Figure 10-53 Data &Time Page

10.6.3 Network Setting

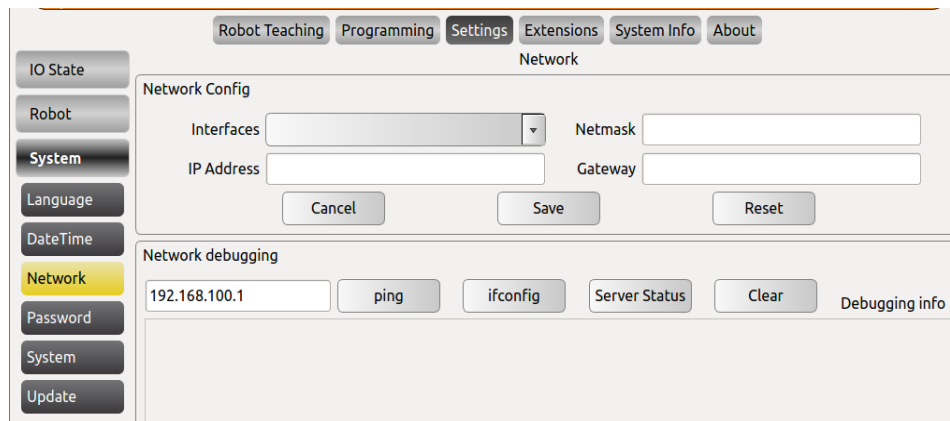

Figure 10-54 Network Page

Network page is used for network settings and is controlled by third party interface.

This page can setup specified name of the NIC and its IP Address, Netmask and Gateway. The network IP address of the external device should in the same network segment with the IP address of the robot.

In the “Network debugging” window, the user can check whether the external device is pinged; check the network card information through “ifconfig”; check whether the port number of the robot server is in the monitoring state through server status.

Restart is required after saving the configuration.

10.6.4 Password Setting

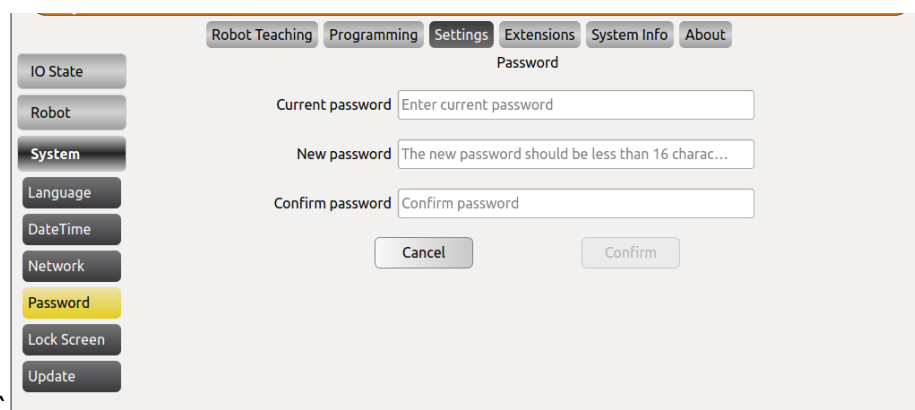

Figure 10-55 Password Page

The password page can set user password (the default password is 1).

After entering the current password, new password and confirm new password, click “OK” to change the password. This page can only be modified by admin user.

After the password is set, the user will need to log in again.

10.6.5 Other Settings

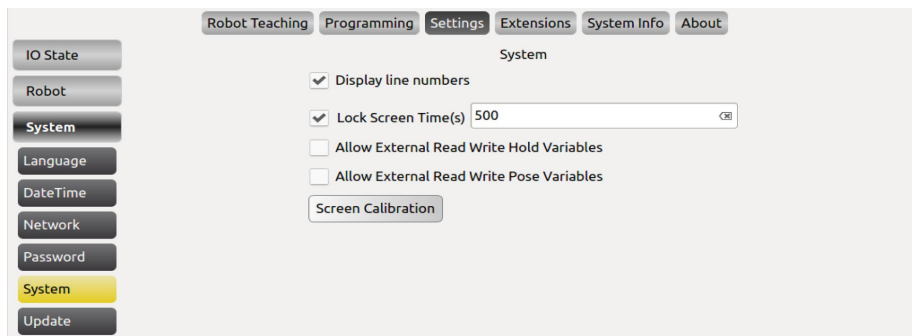

Figure 10-56 Lock Screen Page

Check "Display line number" to switch to the online programming interface, the line number of the program will be displayed in the program logic.

Enter the lock screen time and click "OK" to update the screen lock time. The default lock screen time is 500s.

Check "Allow External Read Write Hold Variables" to read and write hold-type variables through external plug-ins. The plug-in is written by the user, please contact the after-sales service to provide plug-in writing examples.

Check "Allow External Read Write Pose Variables" to read and write retained variables through external plug-ins. The plug-in is written by the user, please contact the after-sales service to provide plug-in writing examples.

10.6.6 Update

Update page can update software and hardware, import or export the project file and reset from a USB memory stick. The update interface can be modified by admin user.



USB disk format supports FAT32 but does not support NTFS format.

1. Factory Reset

Factory Reset means that all the information and data are cleared and returned to the factory state.

The user password will be restored to the initial password "1"; the lock screen time will be restored to the initial lock screen time "500 seconds".

Note: The data configured by the software user will be cleared. Please use this function with caution.

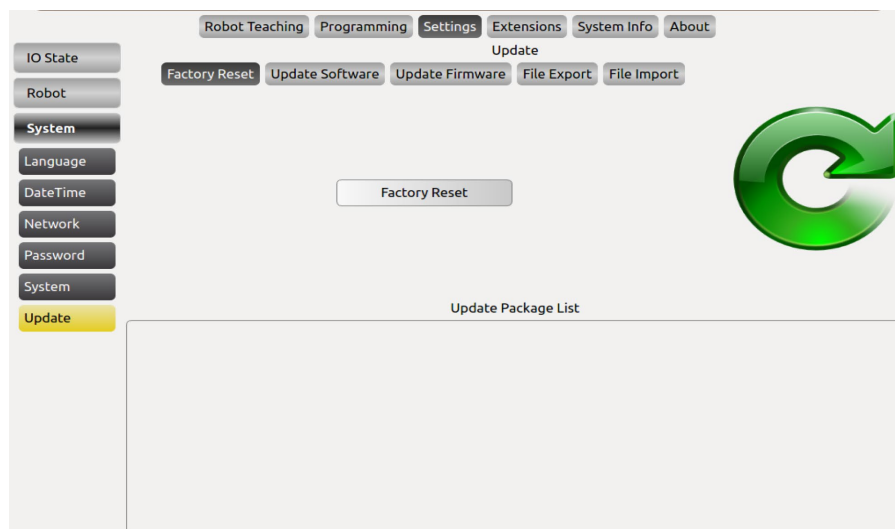

Figure 10-57 Factory Reset Page

2. Update Software/Firmware

The update software is used to upgrade the AUBOPE software. The program name starts with *AuboProgramUpdate*. The firmware installation package is upgraded to upgrade the interface board software. The program name begins with *InterfaceBoard*.

The software/firmware update operation steps are: insert the USB storage device, select the **update software/firmware** button in the interface as shown above; click the **scan software package/scan firmware package**, and identify the software to be updated in the update package list/ Click on the software name entry after the firmware, click **Update Software /Update Firmware**.

- The file directory name can only be English characters.
- The updated software/firmware can only be placed in the root directory.
- The updated software/firmware must be a compressed file ending in: ".aubo".
- After software/firmware update, the control box needs to be powered off before use.

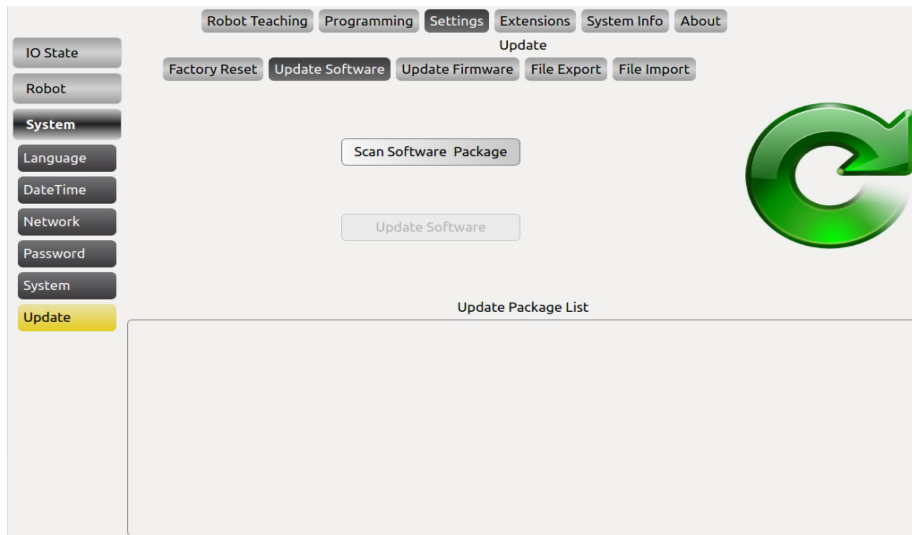

Figure 10-58 Update Software/firmware Page

3. File Export Page

The user can use File Export function to export Logfile and Projects.

The user must insert USB drive to the control box, click "**Scan Device**", select the USB device, then click "File Export" button to export Logfile and Project to the device.

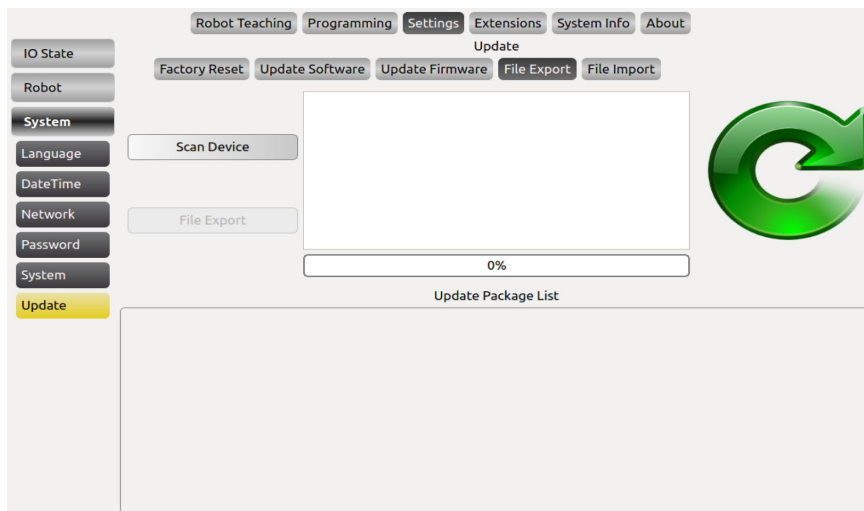

Figure 10-59 File Export Page

4. File Import Page

The user can use File Import function to Import Logfile and Projects.

The user must insert USB drive to the control box, and click "**Scan Aubo File**", select the projects or other files, then click the "**File Import**" button to import files to certain folder.

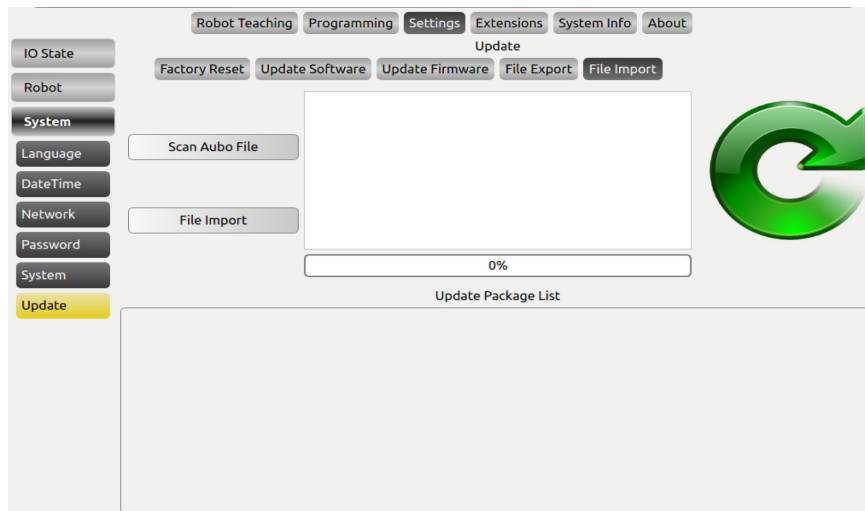

Figure 10-60 File Import Page

10.8 System Info

This interface shows power status of the robot, temperature, joint status, log and other related information.

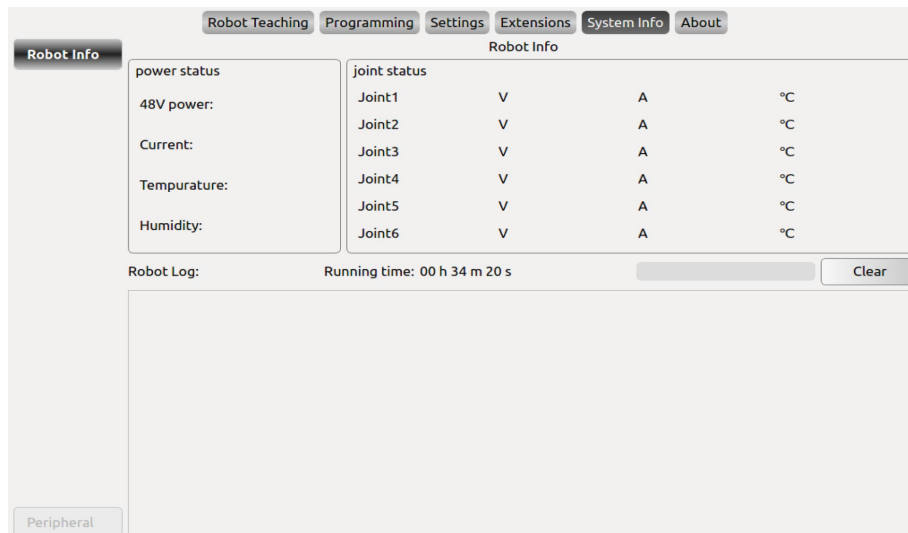

Figure 10-62 System Info Interface

- Power status: the state of 48V power and detection of current, temperature and humidity.
- Joint status: the operating state of the six joints (voltages, currents, and temperatures).
- Robot log: display the log information.
- Running time: the robot operation time.
- The format of Robot Log: date, time, information category and information description.
- Log message filter: there is a text box on the left of the "clear" button, the user could enter key word they want to filter in the upcoming robot operation or project debugging.

10.9 About

This interface shows AUBOPE software version, firmware version, joint hardware version and other related informations.

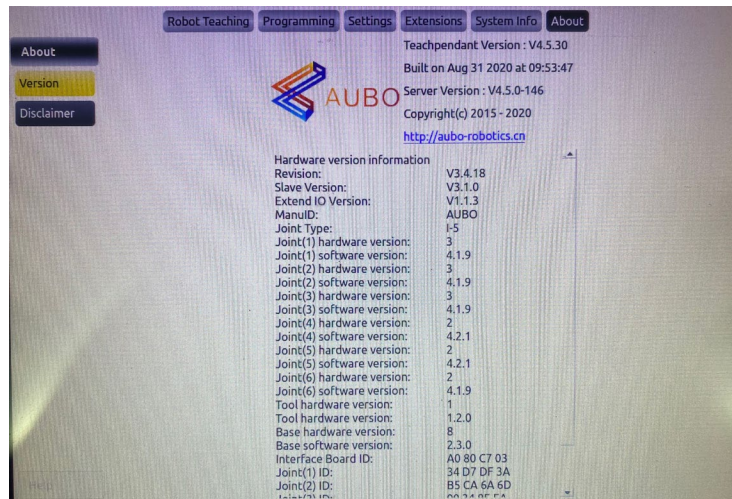

Figure 10-63 About Interface

11. Online Programming

11.1 Instruction

The AUBO robot system provides a convenient programming method, and the user can program the AUBO robot with a small amount of programming foundation, which greatly improves the work efficiency.

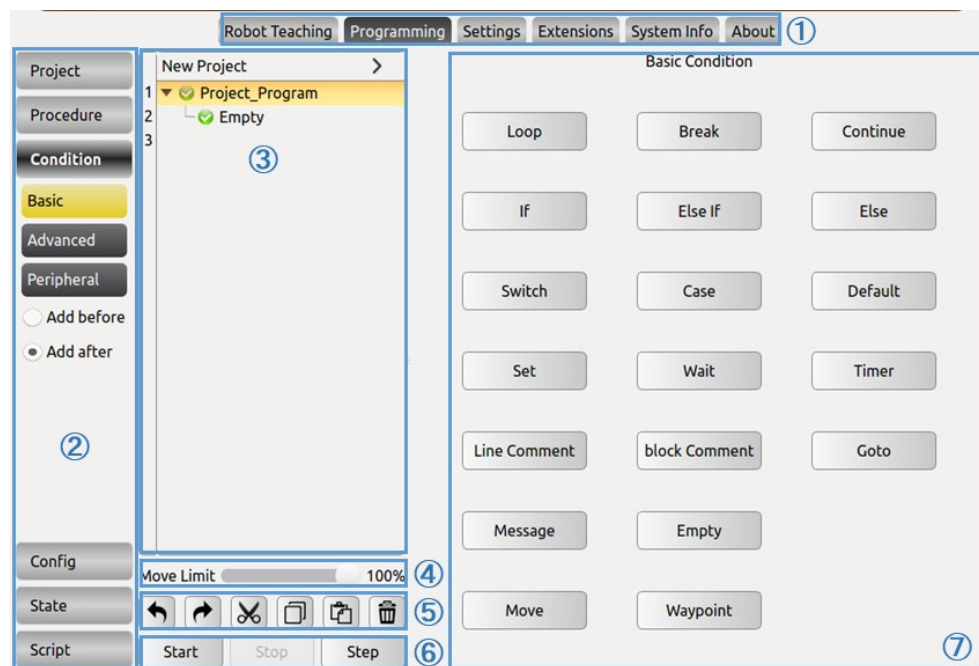

Figure 11-1 Online programming interface

Table 11-1 Online Programming Panel

Number	Name
1	Menu Bar
2	Toolbar
3	Program List
4	Motion Control
5	Program Operation
6	Program Control
7	Property Window

The user's programming of the AUBO robot is mainly carried out in the online programming panel. The panel is mainly divided into the following parts:

1. Menu Bar: You can switch between different panels. The selected button displays a dark background with a light font.
2. Toolbar: With drawer buttons, users can choose according to different task requirements.
3. Program List: Arrange in a logical tree manner to display each command node in the project file, so that the user can read the modified program.

4. Motion Control: Drag the motion limit slider to limit the speed of the project. Currently, it only controls the speed of the Move function.

5. Program Operation: You can operate the commands in the program list.



: The undo command is a program edit control command that can be restored to the last program edit state and can be revoked up to 30 times. Click the Undo button to revert to the last program editing state.



: The undo recovery command is a program edit control command that can restore the last undo command. Click the Restore Undo button to revert to the last undo command.

The cut, copy, and paste commands are program edit control commands.



: Cutting can be used to cut the block.



: Copying enables copying of blocks.



: The paste command can be used to paste the block.



: The delete command is a program edit control command, and the program segment in the same directory can be deleted.

6. Program Control: divided into start, pause, continue, stop and single step.

Start: The first step in the startup of the robot program.

Pause: During the running of the robot, click pause to pause the movement of the robot. Click Continue to continue the action.

Stop: During the robot running, click Stop to stop the robot movement. To make the robot re-action, only click to start, and only run from the beginning according to the program.

Single step: Click on the single step, the robot will execute the first waypoint program in the order of the program (New Project), and click again to execute the next waypoint program.

7. Properties Window: Provide different display panels according to different options in the menu and toolbar, which can operate, display and parameterize specific functions.

11.2 Text Box Editor

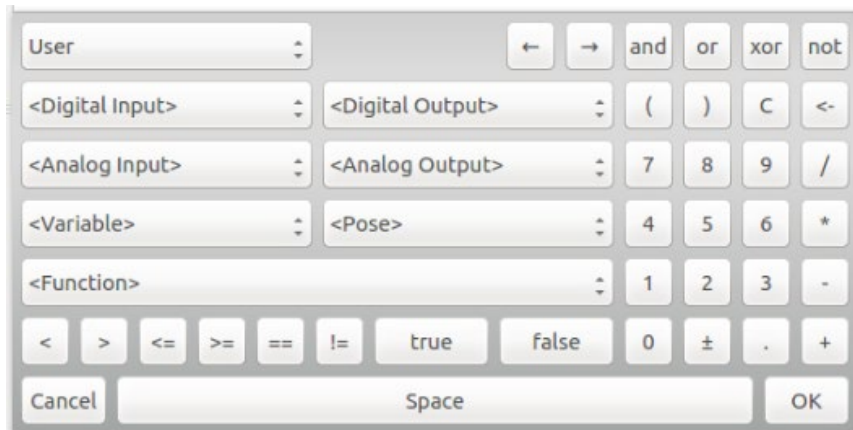

Figure 11-2 Text Editor 1



Figure 11-3 Text Editor 2

Click on the input box in the Teach Pendant interface, the text box editor shown above will pop up, for the use of certain conditions and the input of text and numbers, for example:

- Command conditions, such as loop, if, set, etc.
- Signal conditions, such as user digital I/O, analog I/O.
- Variable condition, when the variable is used, the Arabic numeral indicates the value. In the signal input and output, 0 means invalid, 1 means valid.
- For text input, text input requires the use of the dash "_" instead of the hyphen "-".

11.3 Project Tab

- The first step of writing a new program is to setup a new project.
- Programs are saved as projects.
- There are 4 buttons on the Project tab: New Project, Load Project, Save Project, and Default project.

11.3.1 New Project

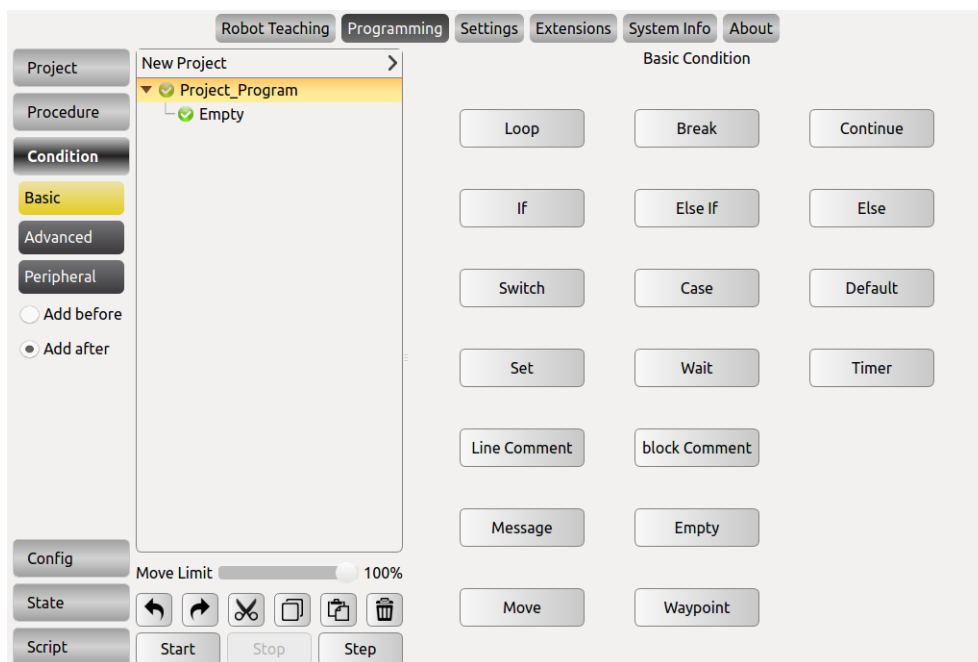

Figure 11-4 Project tab

- Click **【New】** to create a new project. There will be a root node (New Project) on Program Logic. All subsequent commands will be under this root node and the tab will change to Command automatically.
- Click **【Project_Program】**, the Project Root Condition will display and Alias can be modified here.
- When creating a new project, if the current project is not saved, a pop-up prompt will appear. Select the corresponding button according actual needs.
- Click **【Add before】** to insert a new command before selected command.
- Click **【Add after】** to insert a new command after selected command.

11.3.2 Load Project

- Click **【Load】** to find a target program and load.
- The selected program will be loaded in program logic list.
- Click **【Start】** button on the lower left corner to enter auto move tab. Press and hold **【Auto】** button to move robot to initial pose. Click **【OK】** -> **【Start】** , the robot will start to move.
- When there are many project files, search by entering the file name keywords through the search box in the upper right corner.

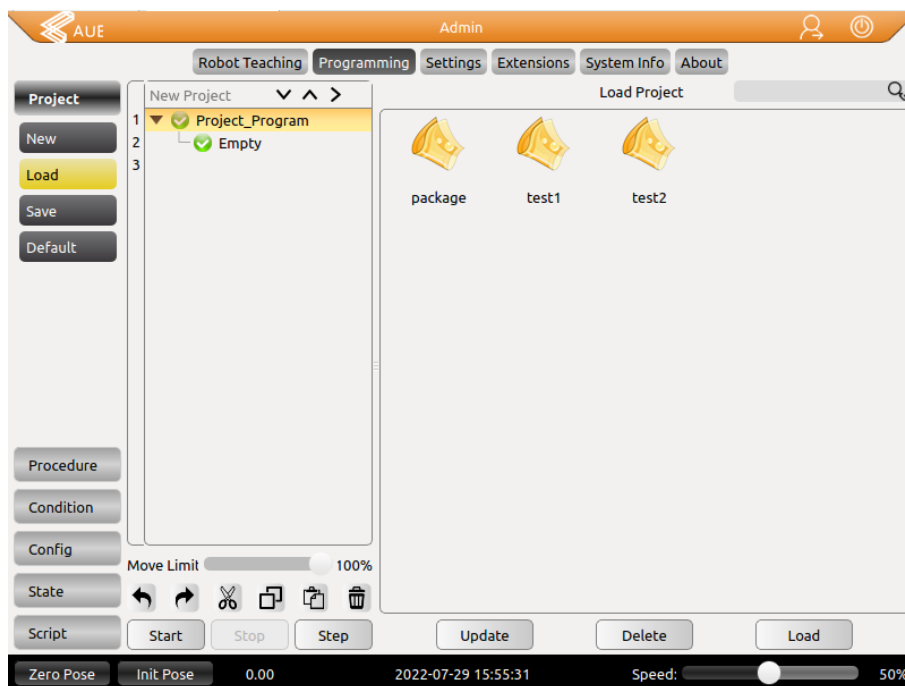

Figure 11-5: Project tab.

11.3.3 Save Project

- Click **【Save】** , enter a name and click **【save】** .
- The project files will be saved as xml format.
- If saved project need to be edited, click **【Save】** again.
- The saved file can be displayed at the Loading Project, refer to the project file and log export for file export.

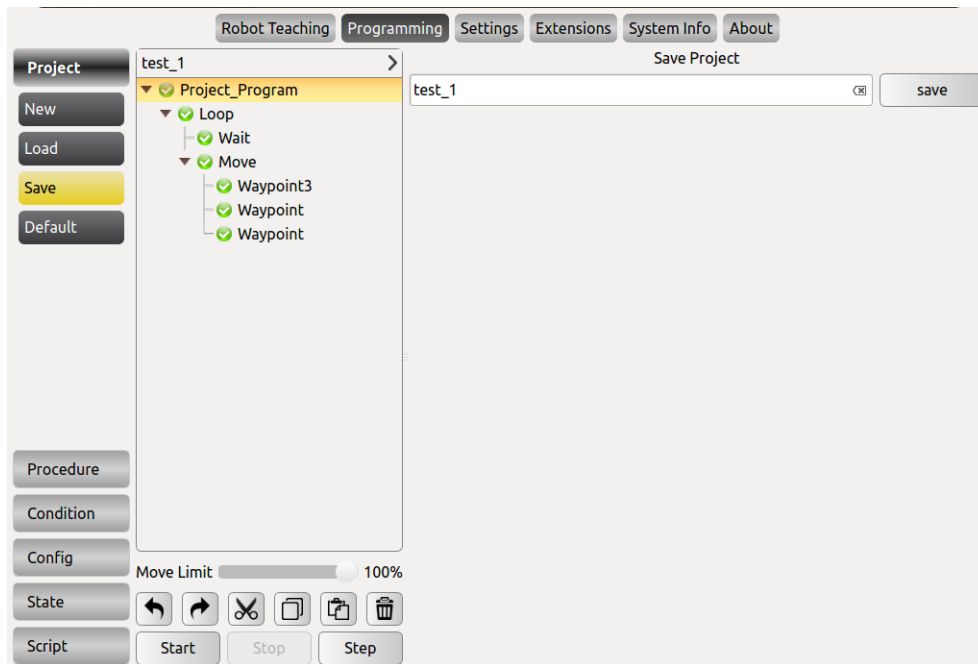

Figure 11-6 Save Project

11.3.4 Default Project

- Click **【Default】** to select the project to be operated in the default project file list and check different options according to the requirements.
- Click **【Auto load default project】** to load the default project automatically after opening the programming environment.
- Click **【Auto load and run default project】** to load and operate the default project automatically after opening the programming environment.
- Click **【Confirm】** button to confirm the default project configuration.

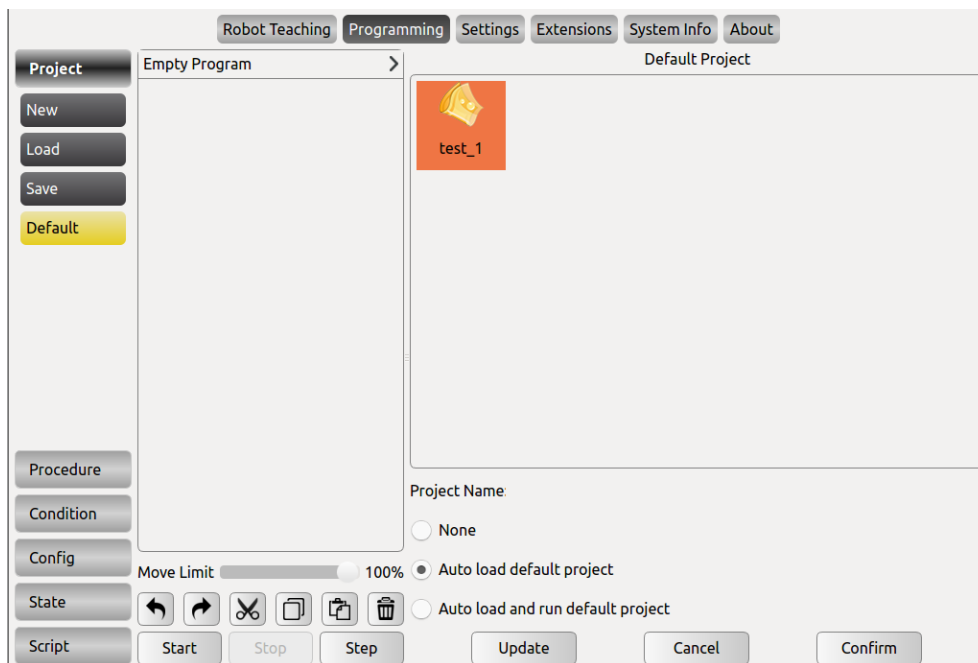

Figure 11-7 Default Project

11.3.5 Move Robot

After editing the Project_Program, start running it, the steps are as follows:

- Click **【Start】** button at the bottom of the interface;
- Press and hold **【Auto】** button until the robot moves to the initial position (the Cancel button changes to OK);
- Click **【OK】** button;
- Click **【Start】** button again.

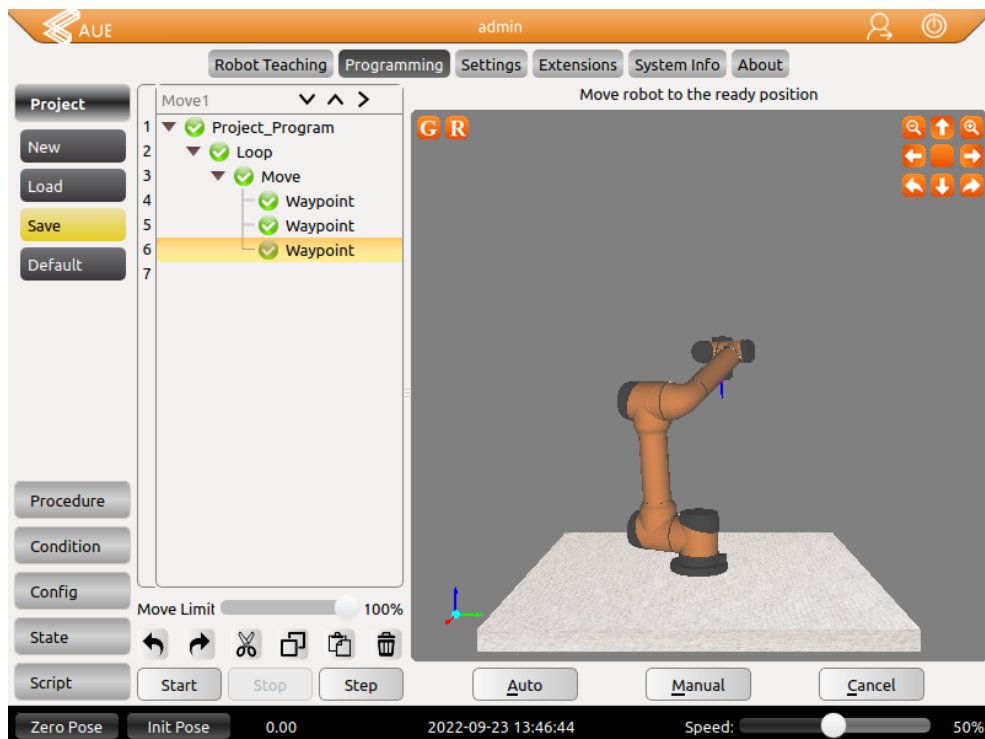

Figure 11-8 Automove

Manually move: Press **【Manual】** button to move robot manually.

Manually move can be used when robot moves undesirably or auto move is not suitable. As shown in Figure 11-9, robot will hit working plane or barriers when moving from C to A under auto move. In this case, manually move can be used to move to safe point (like B) firstly, then move to the initial position A to avoid damaging robot or other equipment.

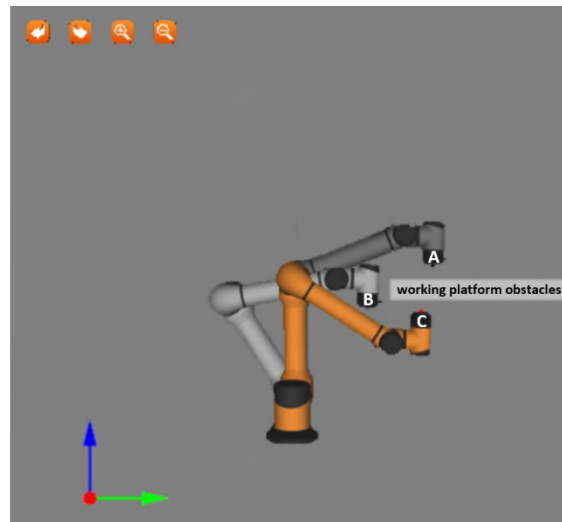

Figure 11-9 Manually move



Compare the position of the simulation with the real manipulator and make sure that the manipulator can perform safely without hitting any working platform barriers.

11.3.6 Project Root Condition

The project root condition can be associated with the project or procedure file by clicking Project_Program in the program tree. In this condition page, certain procedure can be executed when the project is stopped/paused/continued.

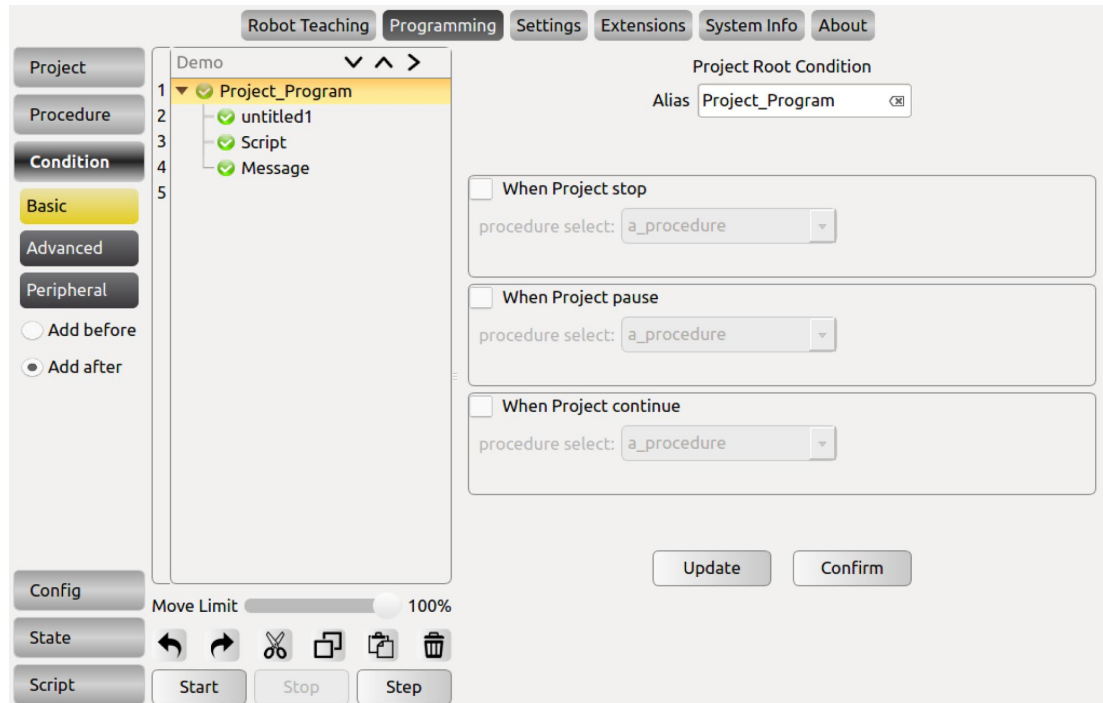

Figure 11-10 Procedure Project

Note:

1. The procedure associated with this root condition of the project cannot include motion functions. Generally, it is a non-time-consuming operation such as setting IOs.
2. Please pay attention to the logical relationship in the project file when using the associated process when suspending/continuing. For example, the setting logic of IO needs to be maintained by the user, and do not conflict with the logic of the main program when continuing.

11.4 Procedure (process)

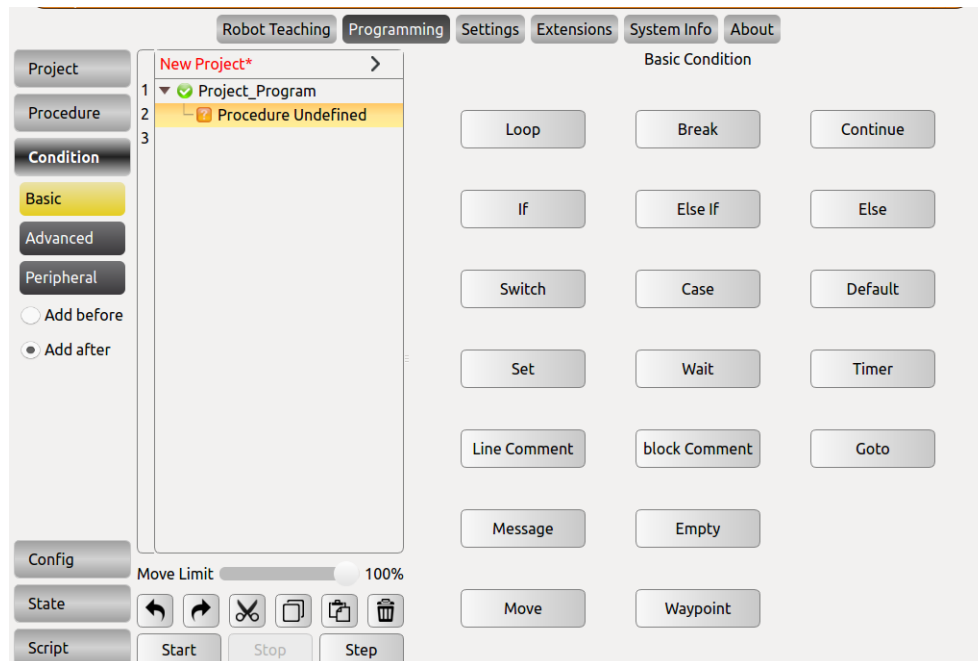

Figure 11-11 Schematic diagram of the sub-project (process)

Procedures (Subprojects) can be used in different program files, as stand-alone files in a task, or be called multiple times in a single program file. The procedure can be either a control project or a controlled project.

The program data contained in the subproject is only the data when the subproject in the main program is activated. Subprojects can be called from one or more locations in the main program based on certain conditions, such as the value of a variable or the input signal of an external device.

- Sub-projects, which can be edited for reuse, are easily loaded into other project blocks.
- New, load, and save engineering methods are consistent with the project management chapter. The list of programs in the subproject shows New Procedure, please pay attention to the distinction.

11.4.1 Calling Subproject Commands (Procedure)

Procedure is a sub-project (process) editing command. In the Procedure block, you can edit the blocks for multiplexing and load them into other project blocks conveniently. Subproject commands can be called in both project files and subproject files.

- Click New in the toolbar project or process, and the project logic displays New Project or New Procedure.
- In the program list, select the logical line that needs to insert the sub-project command, click the advanced condition under the condition of the toolbar, and click Procedure in the property window.

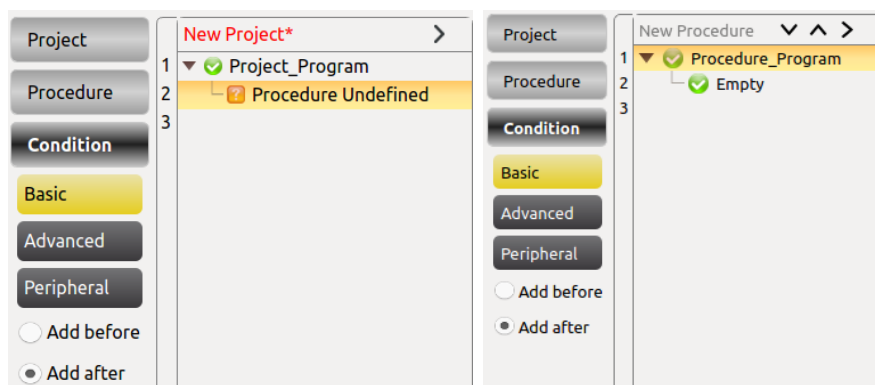

Figure 11-12 Schematic diagram of the new sub-project (process)

- Change the name by clicking Project_Program or Procedure_Program at the program list.

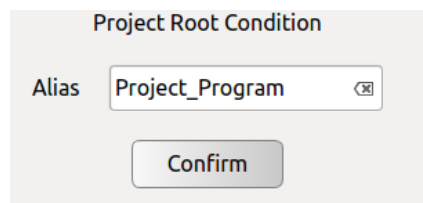

Figure 11-13 Change the subproject (process) name in the program list

Note: The Thread program cannot be inserted in the Procedure process block.

- Select Procedure Undefined at the project list and the subproject file that can be called is displayed in the properties window.
- Select the subproject file and click OK to invoke the subproject file. At this time, the commands in the called subproject file are displayed in the project list.

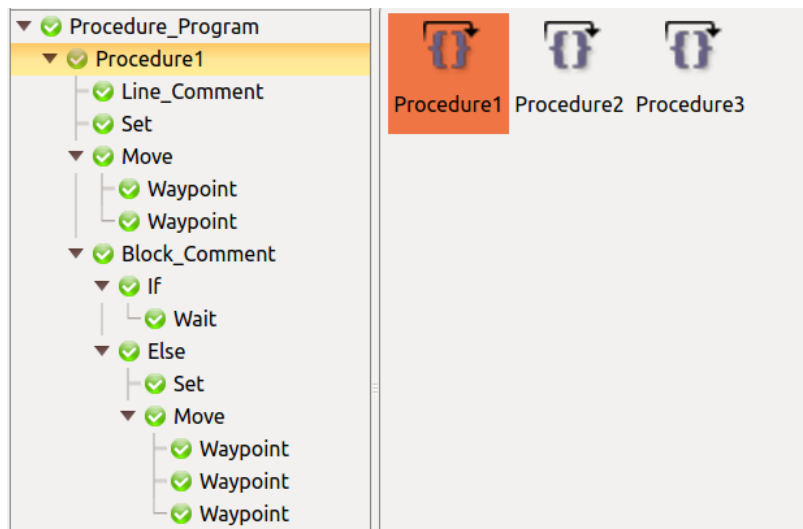

Figure 11-14 Calling the subproject (process) file

- Click the Update button below the procedure loading screen to retrieve the most up-to-date procedures, and confirm your selection.
- Click Remove button to remove this selected Procedure.

11.4.2 Command Group

The Command group command allows the user to specify a sub-project for the server to execute. Using the project command will cause a communication delay between the AUBOPE and the server, whereas there is no communication delay between the host computer and the server in the case of using command group. Therefore, using the command group will make trajectory smoother, and connect the waypoints faster.

- Create a new project or process file, select "advanced conditions", and click the "Command Group command".

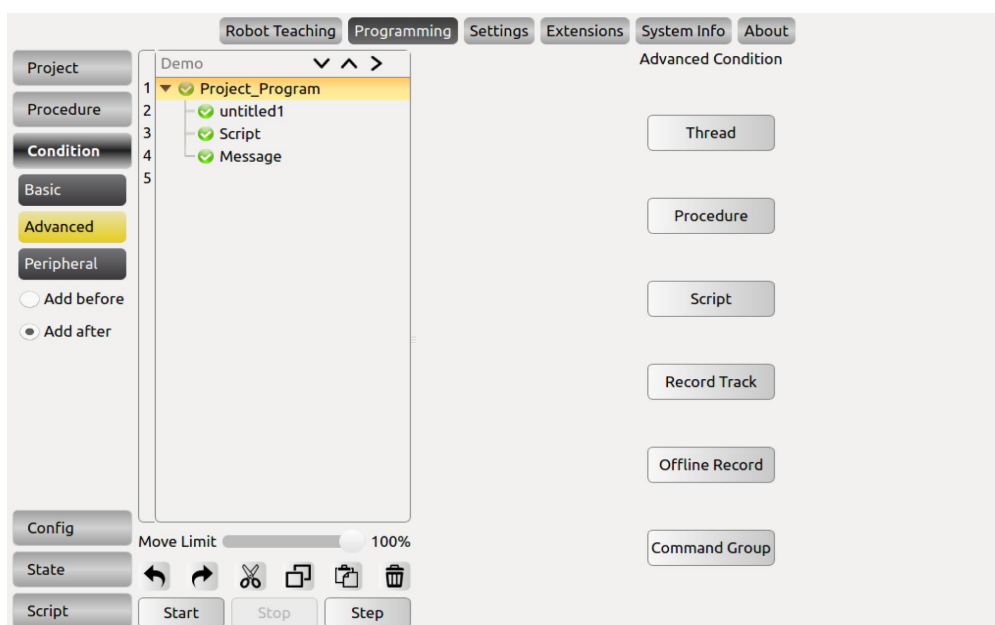

Figure 11-15 Calling the Command Group Command

- Select “Command Group Undefined” in the project list, and the subproject files available for calling will be displayed in the property window. Select the sub-project file and click “OK” to call the sub-project file. At this time, the commands in the called sub-project file are displayed in the project list.

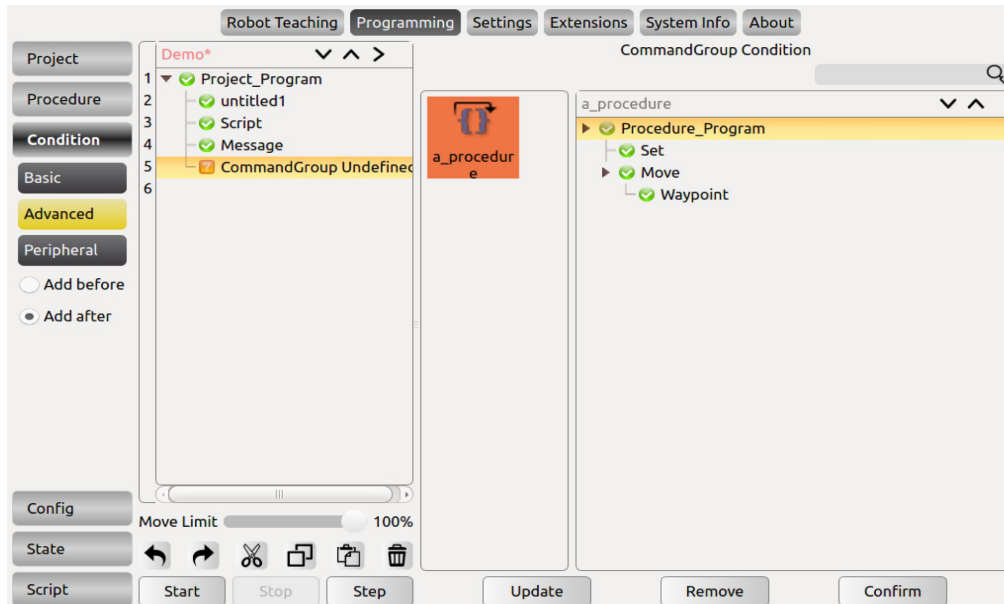

Figure 11-16 Calling the Command Group Command

- Click the “Update” button to retrieve the current file save directory and update the display file changes.

11.5 Move Condition

The Move command is used to move the center point of the robot's end tool between waypoints. The basic point of travel (waypoint) is used to control the operation of the robot, and the waypoint must be placed under the motion command.

- Add a Move node to the list of programs, and there is a Waypoint node below.
- Click the **alias** to the right of the input box to modify the command name.
- Select the Move node to configure the status of the Move command.
- There are three options for the motion properties of the arm: **move joint**, **move line**, and **move track**. A detailed description will be given later.
- Click **Reversal** to copy all Waypoints under the Move node in reverse order.
- Click **Remove** to remove this Move command.
- You must click **Confirm** to confirm that the configuration is complete and **save**.
- The **arc** and **Movep** motion modes in linear motion and trajectory motion belong to Cartesian space trajectory planning and need to be solved by inverse kinematics. Therefore, there may be no solution, multiple solutions, and approximation solutions; and due to the nonlinear relationship between joint space and Cartesian space, axial motion may exceed its maximum speed and acceleration limits.
- The maximum speed and acceleration limits given on the teach pendant for Cartesian space trajectories (Line, arcs, etc.) can only ensure that there is a move that can make the robot reach the limit value. This limit is generally not reached for most configurations of move. Therefore, in actual use, it is recommended that the user perform the simulation first. If it is overspeeding, it is necessary to reduce the speed and acceleration limits and then judge whether the move can be successful.



It is highly recommended to perform offline simulation verification first.

11.5.1 Type of Move

1. Move Joint

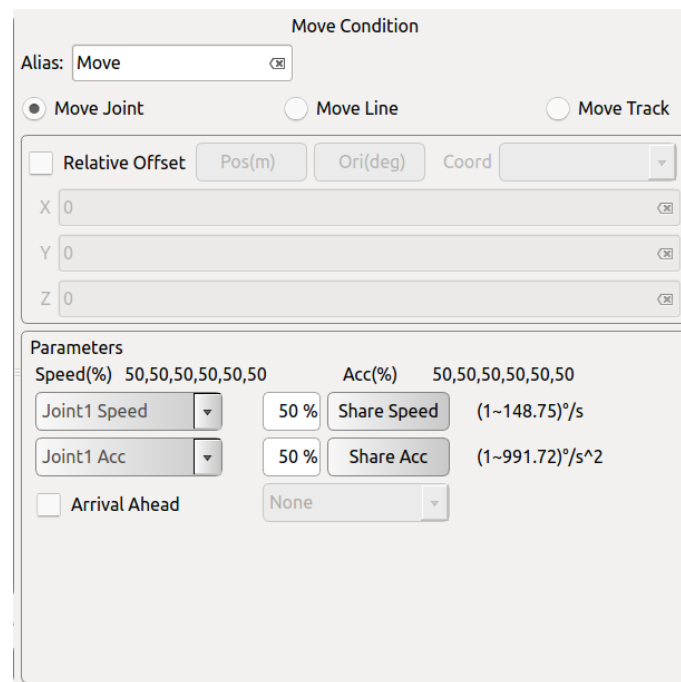

Figure 11-17 Move Joint

According to the joint angles between waypoints and configured motor's limitation of speed and acceleration (six manipulators' common parameters), all the joints move simultaneously to the target waypoint as fast as they can (Both initial velocity and final velocity are 0). The end moving path between these waypoints during the move can be observed on Track display. If you want manipulator to move quickly between waypoints and without considering the TCP's moving path, this movement type is a good choice. **Move Joint** applies for the enough space and moves by the fastest way. As shown below.

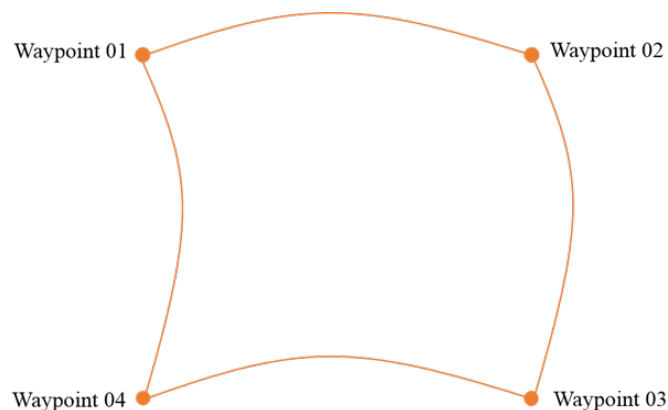

Figure 11-18 Move Joint track

Maximum speed and acceleration of joint:

During joint move, the Speed (%) and Acceleration (%) of joint 1 to 6 can be set respectively. Click the Share Speed or Share Acc button to copy the speed or acceleration to other joints.

2. Move Line

The screenshot shows the 'Move Condition' dialog box with the 'Move Line' radio button selected. The 'Alias' is set to 'Move'. Under 'Relative Offset', 'Pos(m)' is selected, and the 'Coord' is set to 'Base'. The X, Y, and Z coordinates are all set to 0. In the 'Parameters' section, 'End Linear Speed' is set to 50% (1~2000)mm/s, 'End Linear Acc' is set to 50% (1~2000)mm/s^2, and 'Arrival Ahead' is set to None.

Figure 11-19 Move Line

It makes the end-effector moves linearly between waypoints, which means each joint will operate more complex movements to keep end-effector's track in line. Common parameter that applied for this movement type includes the maximum speed and maximum acceleration (represent as mm/s and mm/s²) of needed tools and motion mode. Similar with **Move Joint**, whether a joint can reach and keep maximum speed is determined by the joint displacement and the maximum acceleration parameters. As shown below.

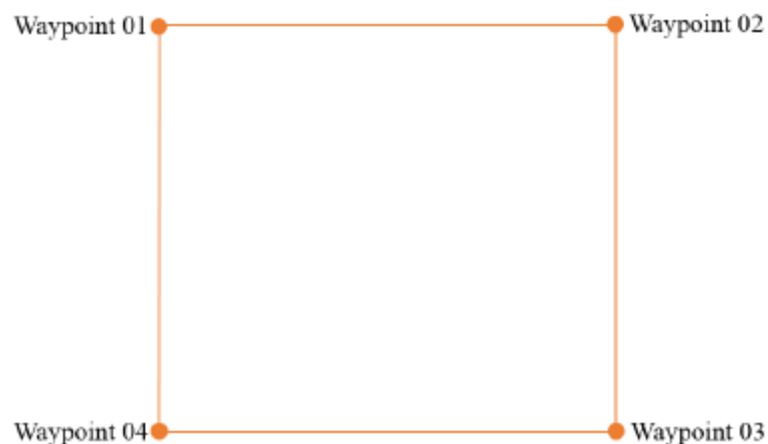

Figure 11-20 Move Line

3. Move Track

In multiple waypoints move track, the corresponding speed and acceleration of joint space and Cartesian space is continuous, and the speed of start and end waypoint is zero during the operation. It provides: Arc (Arc), Cir (Circumference), moveP (smooth transition in linear trajectory), and B_Spline (B-spline curve). When writing a Move Track, there are can only have three waypoints under Arc and Cir, and at least three waypoints (there is no upper limit for theory) is required under MoveP and B_Spline, and Move Joint needs to be inserted before this Move command, the waypoint under Move Joint must be consistent with the first waypoint of this Move command.

Note: If you need to use the Arc move with attitude (arcwithorirot) and the Cir move with attitude (cirwithorirot), the 6 joints of the robot need to support $\pm 360^\circ$ rotation, please contact supplier for details.

A. Arc

Use three-point method to determine the arc and follow a sequence move from start waypoint to end waypoint. It belongs to Cartesian space trajectory planning. Pose changes only influenced by the start point and the end point. The meaning of maximum speed and acceleration is same as **Move Line**. When the **Arc** is selected in the **Track Type**, it is an arc move.

Figure 11-21 Arc Move

B. Circumference

Similar with arc, use three-point method to determine the track of full circle and the direction of movement. Back to the start after completing the entire circumference of the movement. Keep the pose of the start and the end points unchanged during the movement. The meaning of maximum speed and acceleration is same as **Move Line**. When the **Cir** is selected in the **Track Type**, it is a circular move.

The screenshot shows the 'Move Condition' dialog box. At the top, the 'Alias' is set to 'Move'. Below this, three radio buttons are present: 'Move Joint' (unselected), 'Move Line' (unselected), and 'Move Track' (selected). A section for 'Relative Offset' includes a checkbox (unchecked), a unit selector 'Pos(m)', a rotation selector 'Rot(deg)', a coordinate system selector 'Coord' set to 'Base', and three input fields for X, Y, and Z, all containing the value '0'. The 'Parameters' section contains: 'End Linear Speed' set to '50 %' with a range of '(1~2000)mm/s'; 'End Linear Acc' set to '50 %' with a range of '(1~2000)mm/s^2'; 'Arrival Ahead' set to 'None'; and 'Track Type' set to 'Cir' with a 'Loop' count of '1' times. At the bottom, there are three buttons: 'Reversal', 'Remove', and 'Confirm'.

Figure 11-22 Cir Move

C. ArcWithOriRot

Use three-point method to determine the arc and follow a sequence move from start waypoint to end waypoint. It belongs to Cartesian space trajectory planning. The ArcWithOriRot tool points to the direction of the center where the arc move is located. The move trajectory of the tool will maintain the angle between the Z axis in the tool coordinate system and the circular plane where the arc move is located. It is the angle between the first taught point and the plane where the arc move is located.

Figure 11-23 ArcWithOriRot

D. CirWithOriRot

Use three-point method to determine the cir and follow a sequence move from start waypoint to end waypoint. It belongs to Cartesian space trajectory planning. The CirWithOriRot tool points to the direction of the center where the Cir move is located. The move trajectory of the tool will maintain the angle between the Z axis in the tool coordinate system and the circular plane where the Cir move is located. It is the angle between the first taught point and the plane where the Cir move is located.

The screenshot shows the 'Move Condition' dialog box. At the top, the 'Alias' is set to 'Move'. Below this, three radio buttons are present: 'Move Joint', 'Move Line', and 'Move Track', with 'Move Track' selected. A section for 'Relative Offset' includes buttons for 'Pos(m)', 'Rot(deg)', and 'Coord', with 'Base' selected in a dropdown menu. Below this are input fields for X, Y, and Z, all set to 0. A 'Parameters' section contains: 'End Linear Speed' at 50% (1~2000)mm/s, 'End Linear Acc' at 50% (1~2000)mm/s^2, 'Arrival Ahead' set to None, and 'Track Type' set to CirWithOriRot. At the bottom are 'Reversal', 'Remove', and 'Confirm' buttons.

Figure 11-24 CirWithOriRot

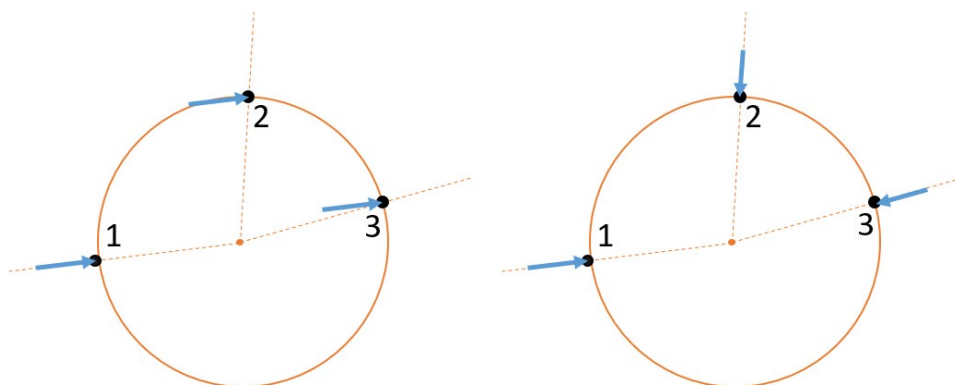

Figure 11-25 Cir (L) and CirWithOriRot (R)

E. MoveP

MoveP: The adjacent two straight lines are smoothly transitioned by arcs at the blending radius. The attitude change during operation is only affected by the maximum velocity and acceleration in the same linear motion.

MoveP is a smooth transition of arcs between multiple linear trajectories. The running characteristics of the blending radius are continuous motion and will not stop at this waypoint. The smaller the blending radius value is, the larger the corner of the path is. Conversely, the larger the blending radius value, the smaller the corner of the path.

Example

Insert two move and set the following three path points (1), (1, 2, 3), the first Move is joint motion, the second Move is MoveP motion, after running the program MoveP as shown in the following figure run (1-2'-3'-3).

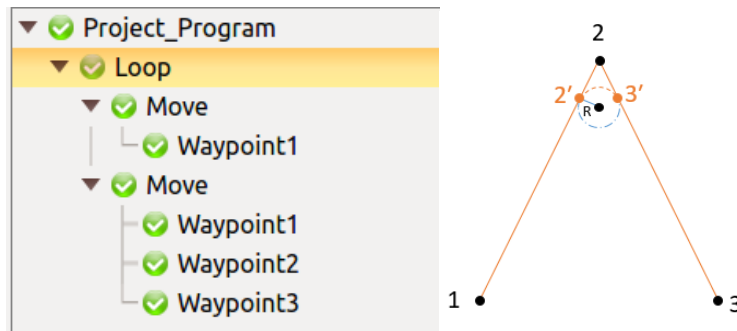

Figure 11-26 Blending radius motion track

F. B_Spline

B_Spline fits a path curve according to a given path point. The more waypoints are used to generate the fitted curve, the closer the fitted curve is to the expected. The B-spline curve is a curve that smooth through all the given waypoints. Note that the beginning and end of the curve cannot be closed.

Example

Insert a move and set the four waypoints as shown below (1, 2, 3, 4). After running the program, the B-spline curve runs as shown in the following figure.

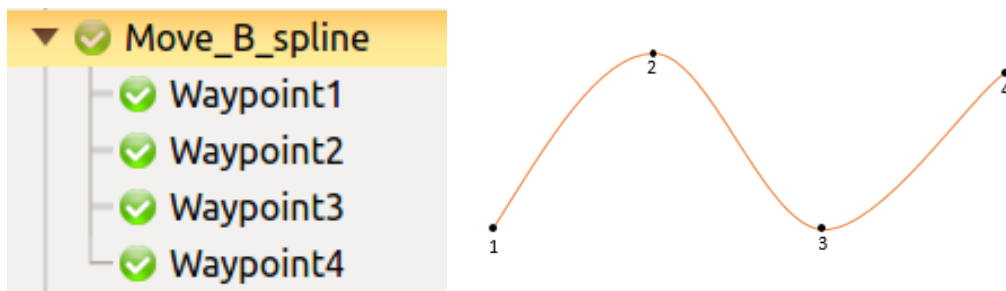

Figure 11-27 B-spline curve

G. MoveProcess

MoveProcess: The two adjacent straight lines are smoothly transitioned by spline curve according to the set blending radius. The position and pose dimensions are planned synchronously throughout the move, and they both reach a continuous grade of C2 while satisfying the speed and acceleration constraints. Compared with MoveP, the pose of the interpolation point of MoveProcess can change uniformly with the change of the set waypoint attitude during the move, and the inflection point of the path can adaptively decelerate with the change of the curvature of the path, which makes the move of the manipulator is smoother.

Note: C2 represents the second-order continuous, that is, the acceleration is continuous.

Example

Insert two move and set the following three path points (1), (1, 2, 3), the first Move is joint motion, the second Move is MoveProcess motion, after running the program MoveProcess as shown in the following figure run (1-2'-3'-3).

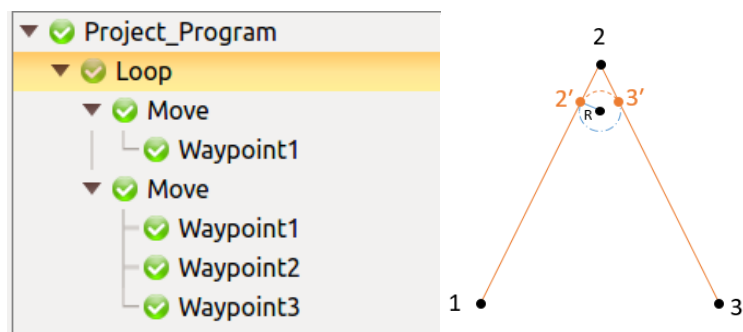

Figure 11-28 MoveProcess

11.5.2 Arrival Ahead

By choosing "Arrival Ahead" type (Distance, Time, or Blend Radius), the function can improve the work efficiency of the manipulator. This function can adjust the robot path according to the user's configuration, so that the robot path will have the situation of not reaching one or multiple preset waypoints. Please check the Arrival Ahead type, feature, and scope of application in the table below:

Table 11-2 Arrival Ahead type, feature, and scope of application

Type	Feature	Scope of application
Distance	Target distance, arrival ahead	Move Joint
Time	Target time, arrival ahead	Move Joint
Blend Radius	Target blend radius, arrival ahead	Move Joint, Line, Arc, Cir, Arcwithorirot, Cirwithorirot

Precaution:

- The setting parameter is limited by the middle value of the two waypoints, and the middle value shall prevail after exceeding.
- The singularity in the blending process or the movement speed is too fast will cause the early arrival setting to be cancelled.
- The running trajectory will be set within the area where the blending radius is located.
- The trajectory of the running trajectory outside the blending radius is consistent with the trajectory not set in advance.
- It is not recommended to add in advance in the first move in the project file.
- The arrival ahead time cannot exceed the move time, and the arrival ahead distance and blend radius cannot exceed the move distance, otherwise the move will fail.

Examples of the Arrival Ahead function:

1. Arrival Ahead – Distance/Time

Move J – Move J

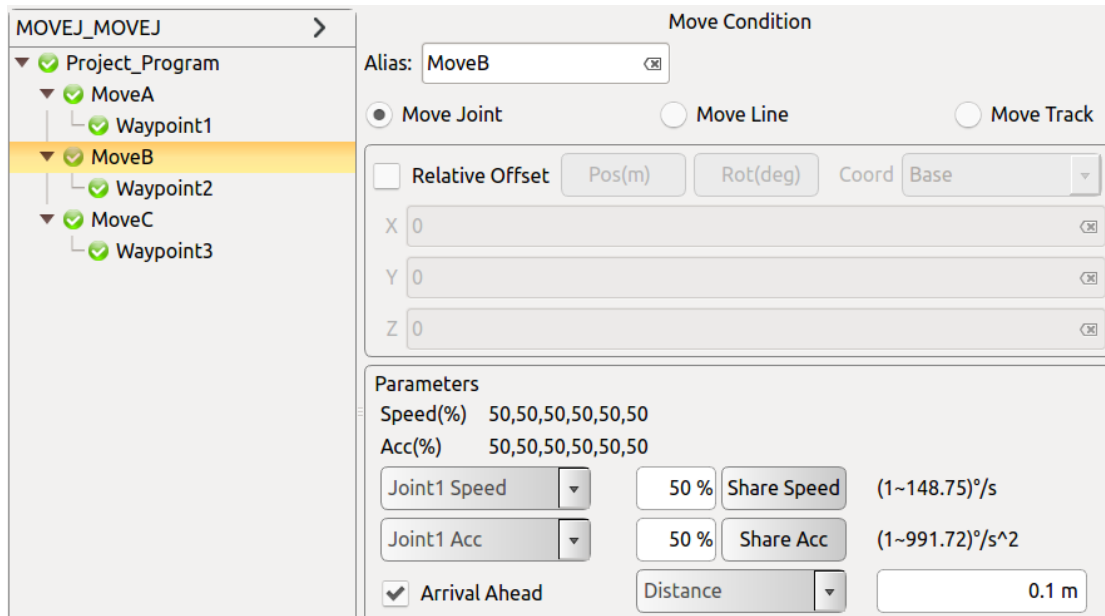

Figure 11-29 Arrival Ahead – Distance/Time, Move J – Move J Trajectory Example

- Insert three Move Joint commands (moveA, moveB, moveC), set waypoints (1), (2), (3) respectively,
- Do not set arrival ahead, the running track is 1-2-3,
- In MoveB, activate arrival ahead. After setting certain distance or time, the running trajectory is 1-2'-3.

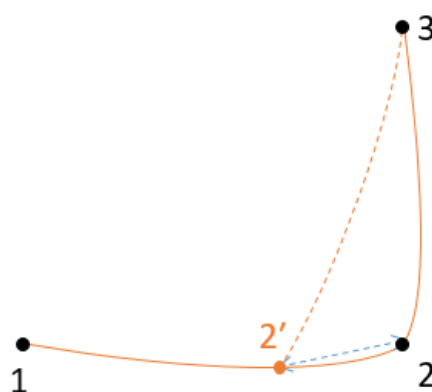

Figure 11-30 Arrival Ahead – Distance/Time, Move J – Move J Trajectory Example

2. Arrival Ahead – Blend Radius

1) Move J – Move J

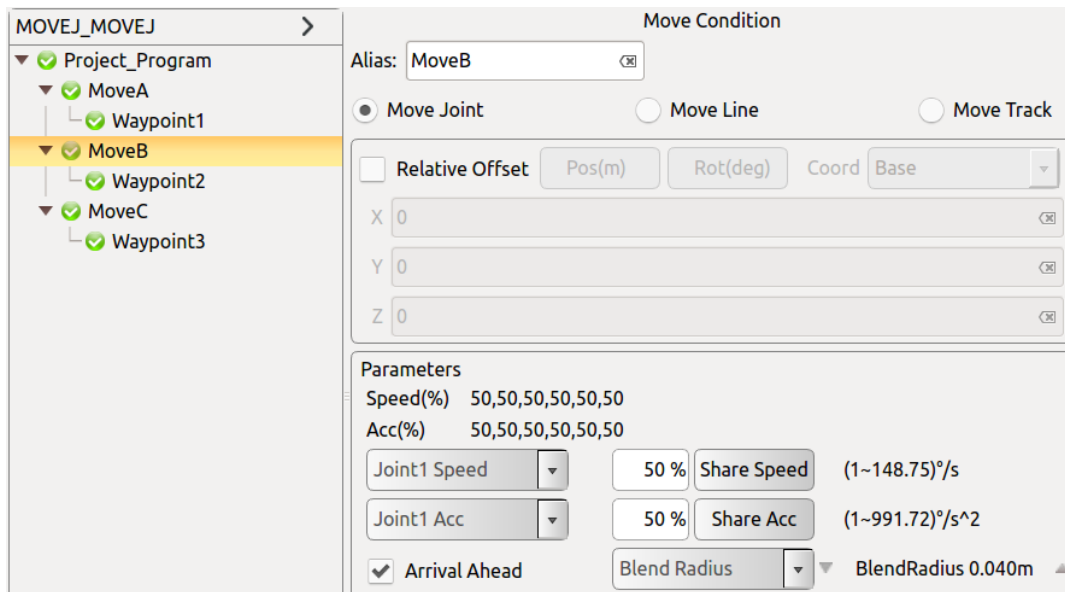

Figure 11-31 Arrival Ahead – Blend Radius, Move J – Move J Trajectory Example

- Insert three Move Joint commands (moveA, moveB, moveC), set waypoints (1), (2), (3) respectively,
- Do not set arrival ahead, the running track is 1-2-3,
- In MoveB, activate arrival ahead. After setting certain Blend Radius value, the running trajectory is 1-2'-3'-3.

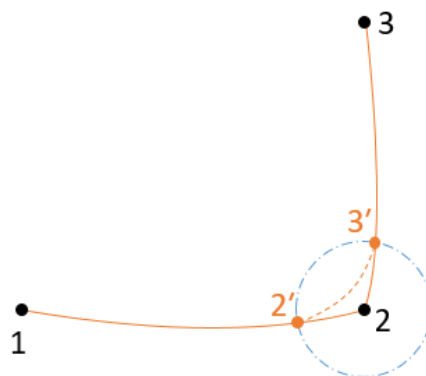

Figure 11-32 Arrival Ahead – Blend Radius, Move J – Move J Trajectory Example

2) Move J – Move Arc

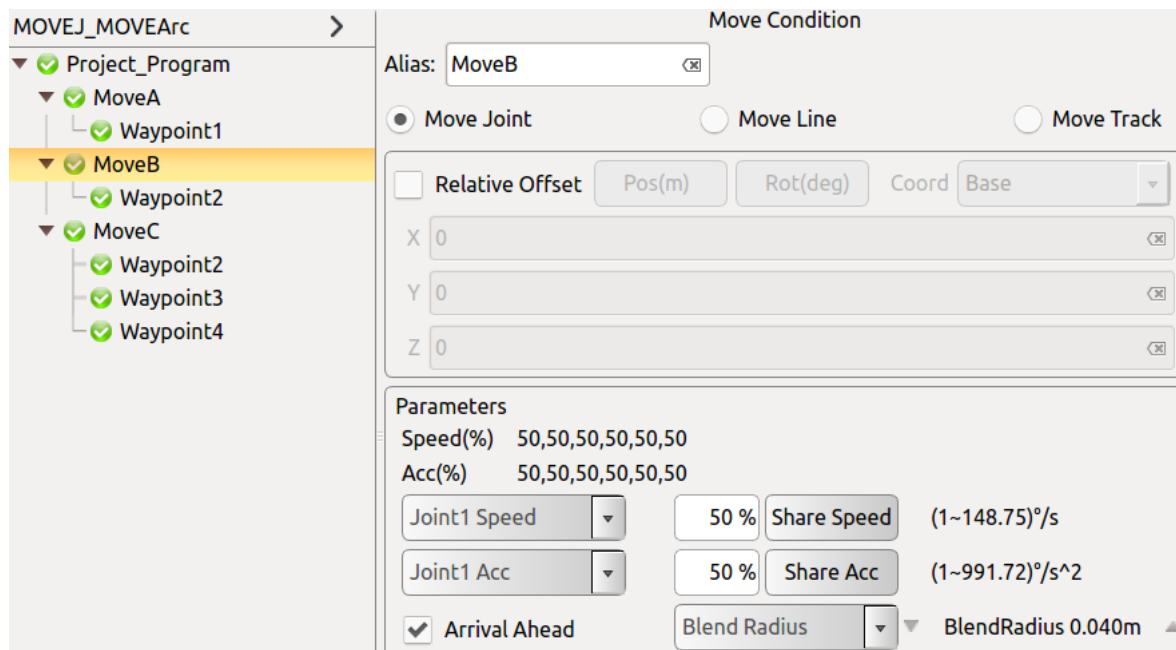

Figure 11-33 Arrival Ahead – Blend Radius, Move J – Move Arc Trajectory Example

- Insert two Move Joint commands (moveA, moveB), set waypoints (1), (2) respectively.
- Insert one Move Track - Arc (moveC), set waypoints (2, 3, 4).
- Do not set arrival ahead, the running track is 1-2-3-4.
- In MoveB, activate arrival ahead. After setting certain Blend Radius value, the running trajectory is 1-2'-3'-3-4.

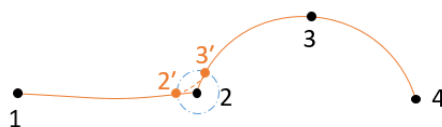

Figure 11-34 Arrival Ahead – Blend Radius, Move J – Move Arc Trajectory Example

3) Move J – Move Cir

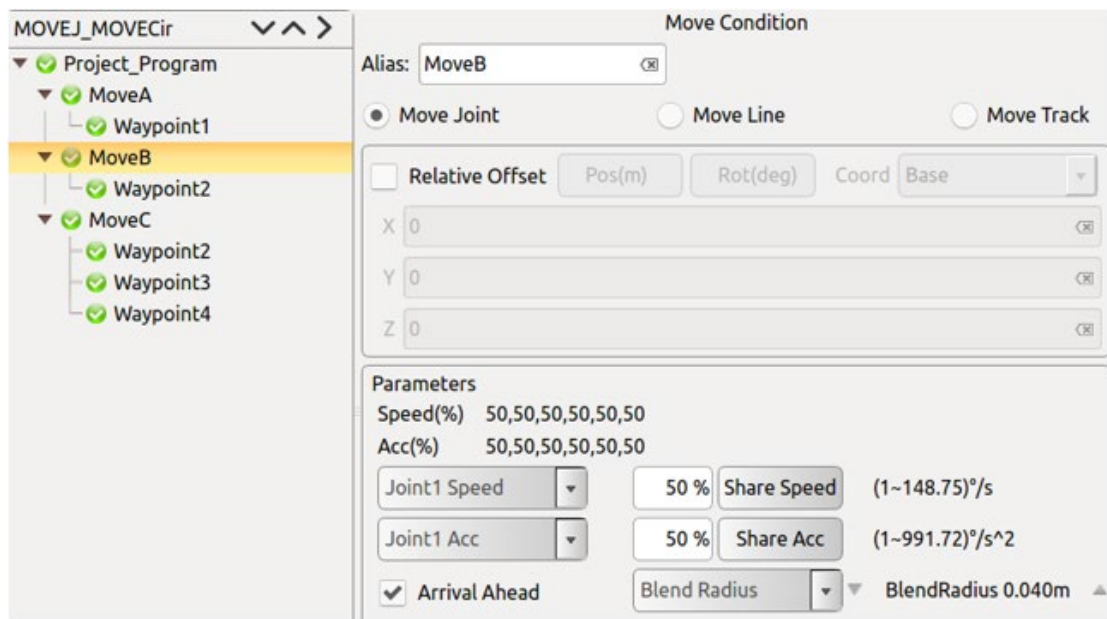

Figure 11-35 Arrival Ahead – Blend Radius, Move J – Move Cir Trajectory Example

- Insert two Move Joint commands (moveA, moveB), set waypoints (1), (2) respectively.
- Insert one Move Track – Cir (moveC), set waypoints (2, 3, 4).
- Do not set arrival ahead, the running track is 1-2-3-4.
- In MoveB, activate arrival ahead. After setting certain Blend Radius value, the running trajectory is 1-2'-3'-3-4.

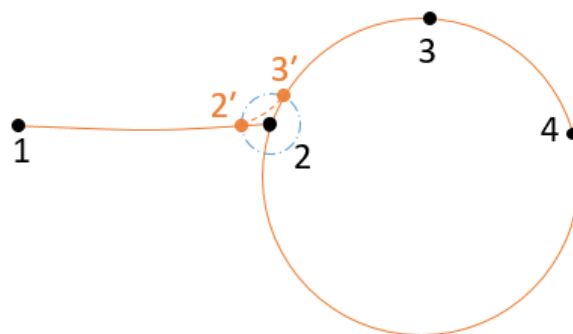

Figure 11-36 Arrival Ahead – Blend Radius, Move J – Move Cir Trajectory Example

4) Move Arc – Move J

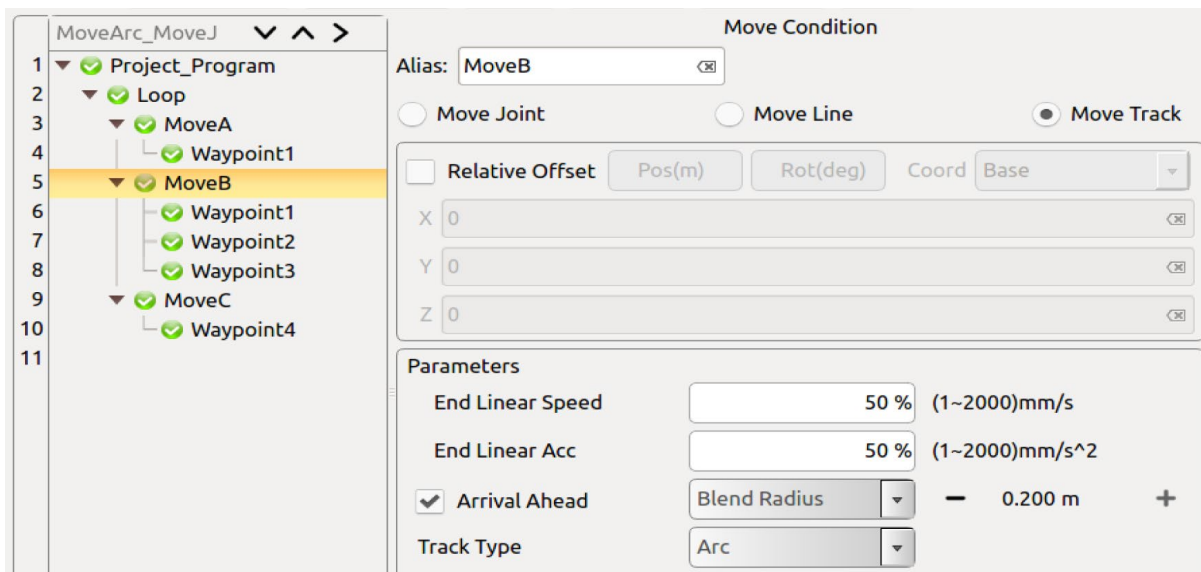

Figure 11-37 Arrival Ahead – Blend Radius, Move Arc – Move J Trajectory Example

- Insert two Move Joint commands (moveA, moveC), set waypoints (1), (4) respectively.
- Insert one Move Track - Arc (moveB), set waypoints (1, 2, 3).
- Do not set arrival ahead, the running track is 1-2-3-4.
- In MoveB, activate arrival ahead. After setting certain Blend Radius value, the running trajectory is 1-2-2'-3'-4.

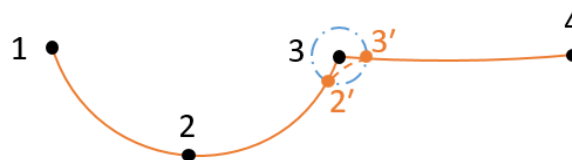

Figure 11-38 Arrival Ahead – Blend Radius, Move Arc – Move J Trajectory Example

5) Move Arc – Move L

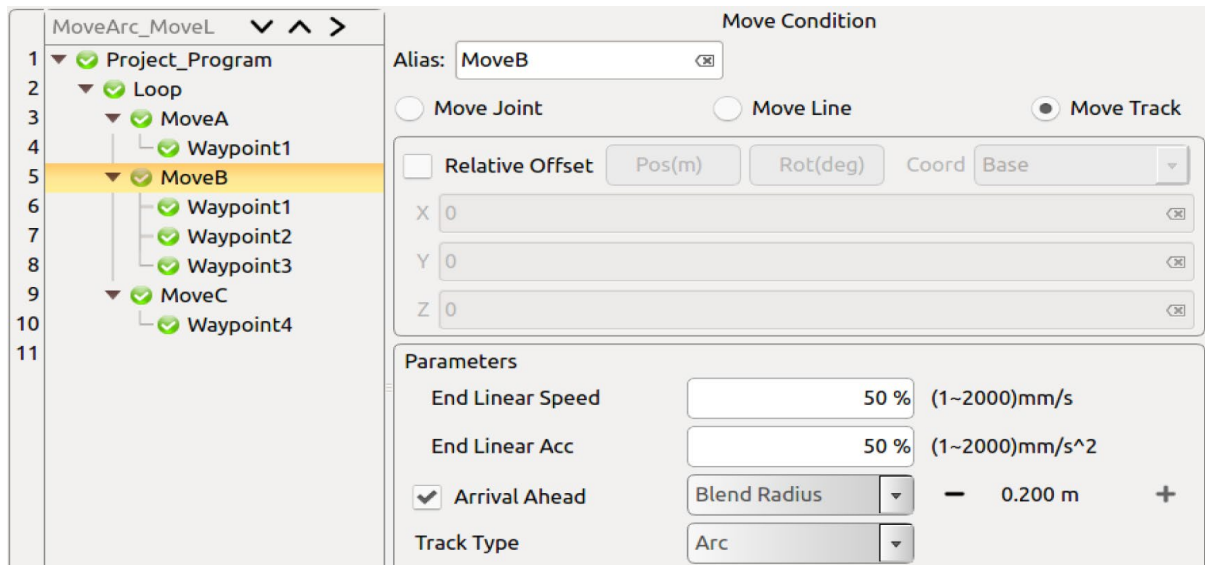

Figure 11-39 Arrival Ahead – Blend Radius, Move Arc – Move L Trajectory Example

- Insert one Move Joint commands (moveA), set waypoints (1).
- Insert one Move Track – Arc (moveB), set waypoints (1, 2, 3).
- Insert one Move Line commands (moveC), set waypoints (4).
- Do not set arrival ahead, the running track is 1-2-3-4.
- In MoveB, activate arrival ahead. After setting certain Blend Radius value, the running trajectory is 1-2-2'-3'-4.



Figure 11-40 Arrival Ahead – Blend Radius, Move Arc – Move L Trajectory Example

6) Move Arc – Move Arc

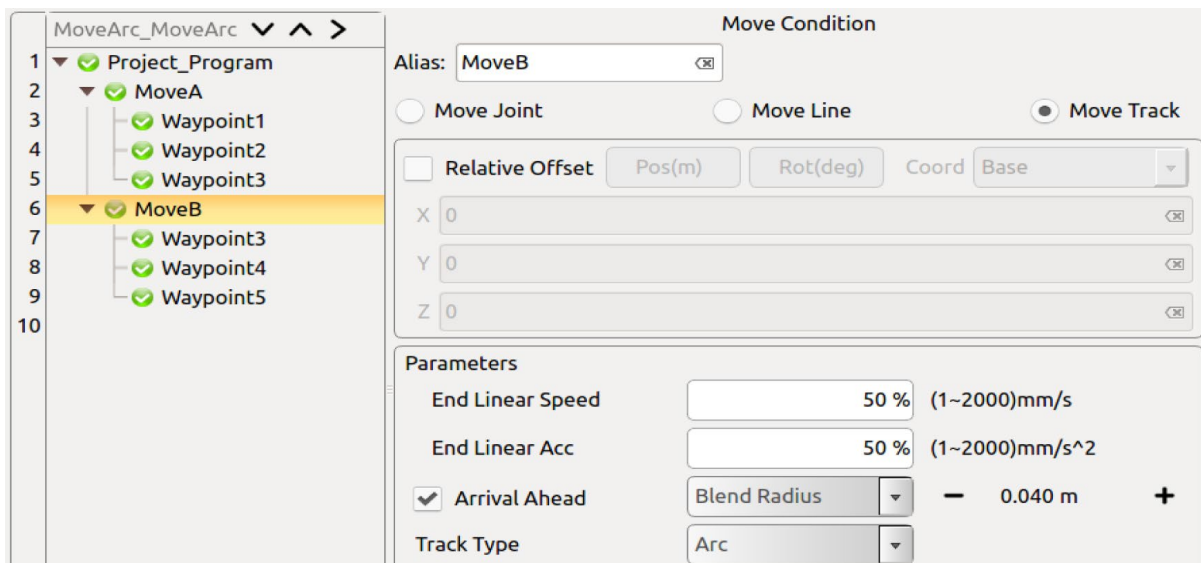

Figure 11-41 Arrival Ahead – Blend Radius, Move Arc – Move Arc Trajectory Example

- Insert Two Move Track – Arc (moveA, moveB), set waypoints (1, 2, 3), (3, 4, 5).
- Do not set arrival ahead, the running track is 1-2-3-4-5.
- In MoveB, activate arrival ahead. After setting certain Blend Radius value, the running trajectory is 1-2-3'-4'-4-5.

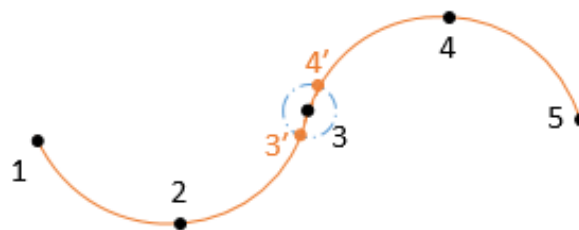

Figure 11-42 Arrival Ahead – Blend Radius, Move Arc – Move Arc Trajectory Example

7) Move L – Move L

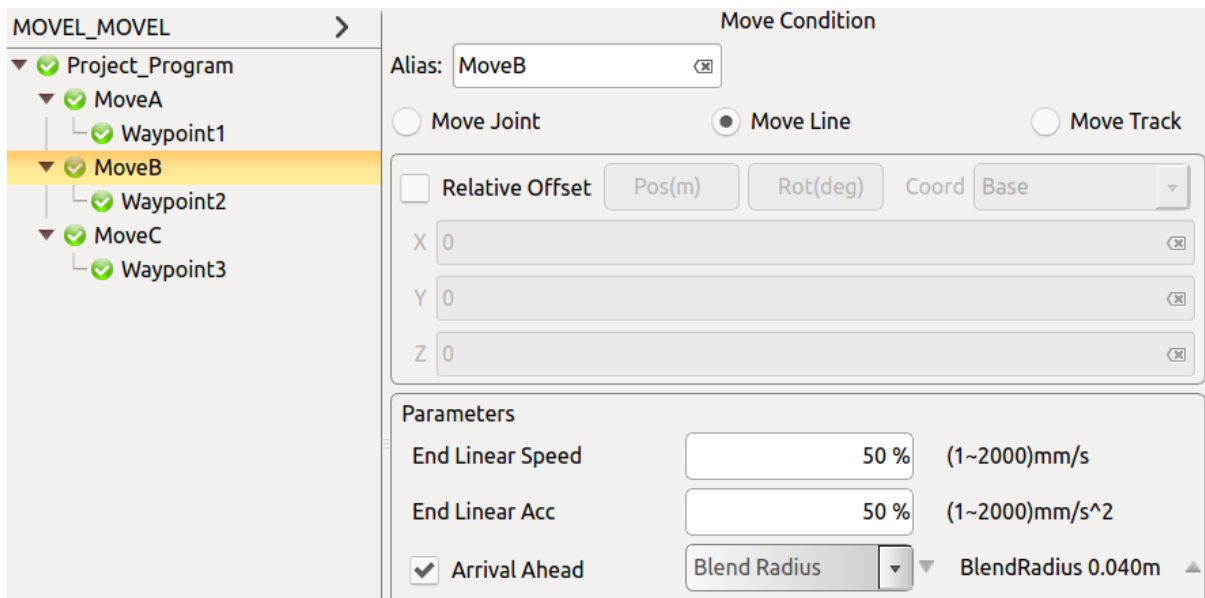

Figure 11-43 Arrival Ahead – Blend Radius, Move L – Move L Trajectory Example

- Insert three Move Line (moveA, moveB, moveC), set waypoints (1), (2), (3).
- Do not set arrival ahead, the running track is 1-2-3.
- In MoveB, activate arrival ahead. After setting certain Blend Radius value, the running trajectory is 1-2'-3'-3.

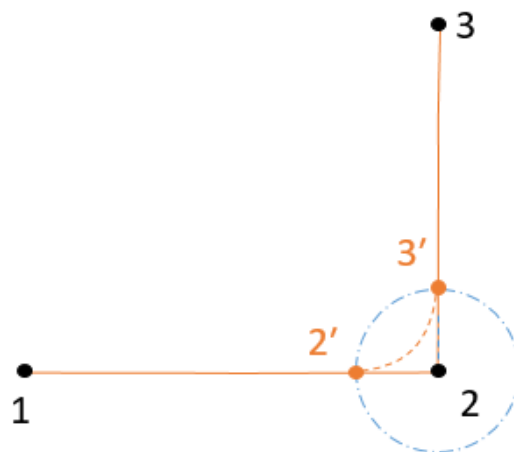

Figure 11-44 Arrival Ahead – Blend Radius, Move L – Move L Trajectory Example

8) Move L – Move Arc

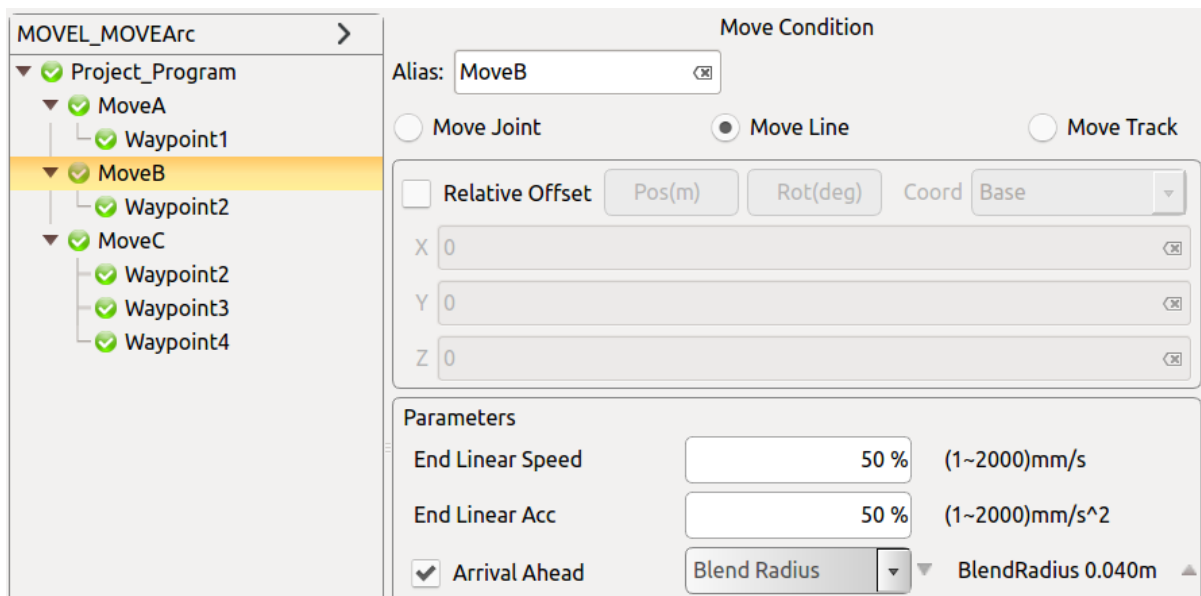

Figure 11-45 Arrival Ahead – Blend Radius, Move L – Move Arc Trajectory Example

- Insert two Move Joint commands (moveA, moveB), set waypoints (1), (2) respectively.
- Insert one Move Track – Arc (moveC), set waypoints (2, 3, 4).
- Do not set arrival ahead, the running track is 1-2-3-4.
- In MoveB, activate arrival ahead. After setting certain Blend Radius value, the running trajectory is 1-2'-3'-3-4.

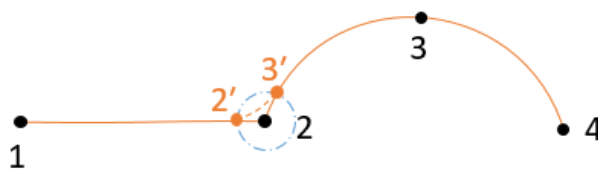

Figure 11-46 Arrival Ahead – Blend Radius, Move L – Move Arc Trajectory Example

9) Move L – Move Cir

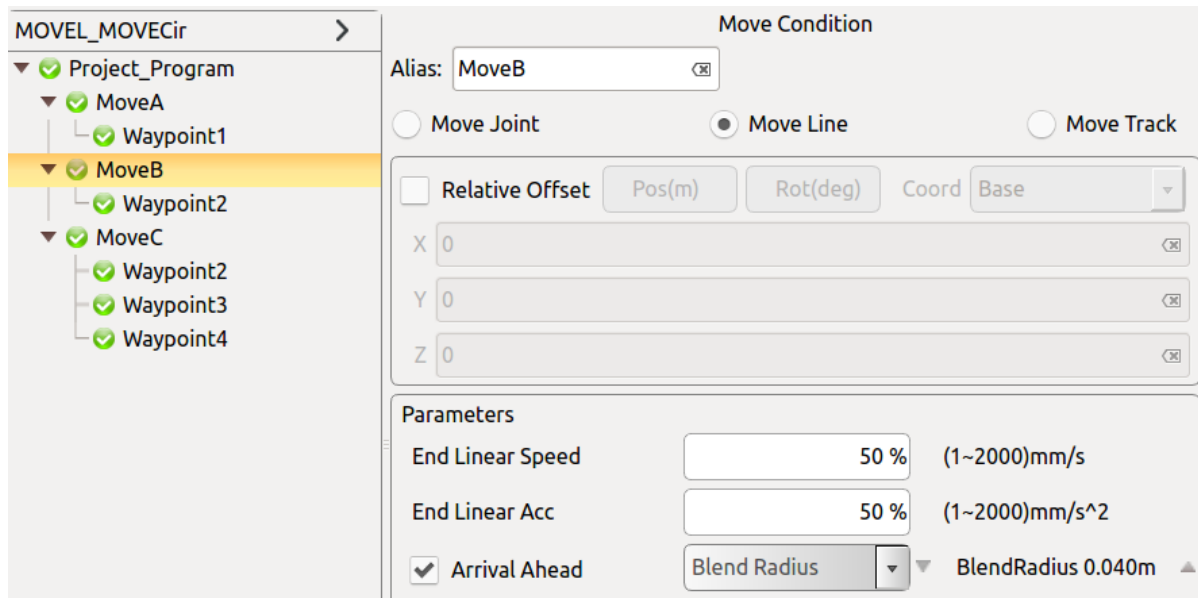

Figure 11-47 Arrival Ahead – Blend Radius, Move L – Move Cir Trajectory Example

- Insert two Move Joint commands (moveA, moveB), set waypoints (1), (2) respectively.
- Insert one Move Track - Cir (moveC), set waypoints (2, 3, 4).
- Do not set arrival ahead, the running track is 1-2-3-4.
- In MoveB, activate arrival ahead. After setting certain Blend Radius value, the running trajectory is 1-1'-2'-3-4.

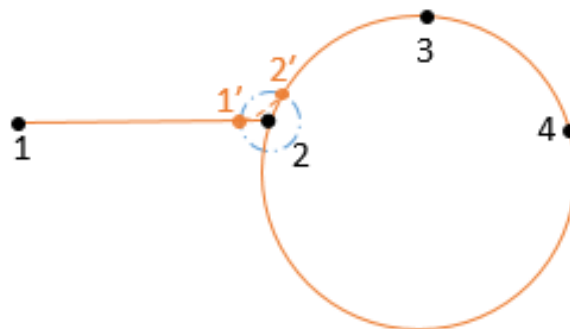

Figure 11-48 Arrival Ahead – Blend Radius, Move L – Move Cir Trajectory Example

11.5.3 Waypoint

Waypoint is an important part of the AUBO i series of robot programs. It represents the point at which the robot end will arrive. Usually, the motion track at the end of the robot consists of two or more waypoints.

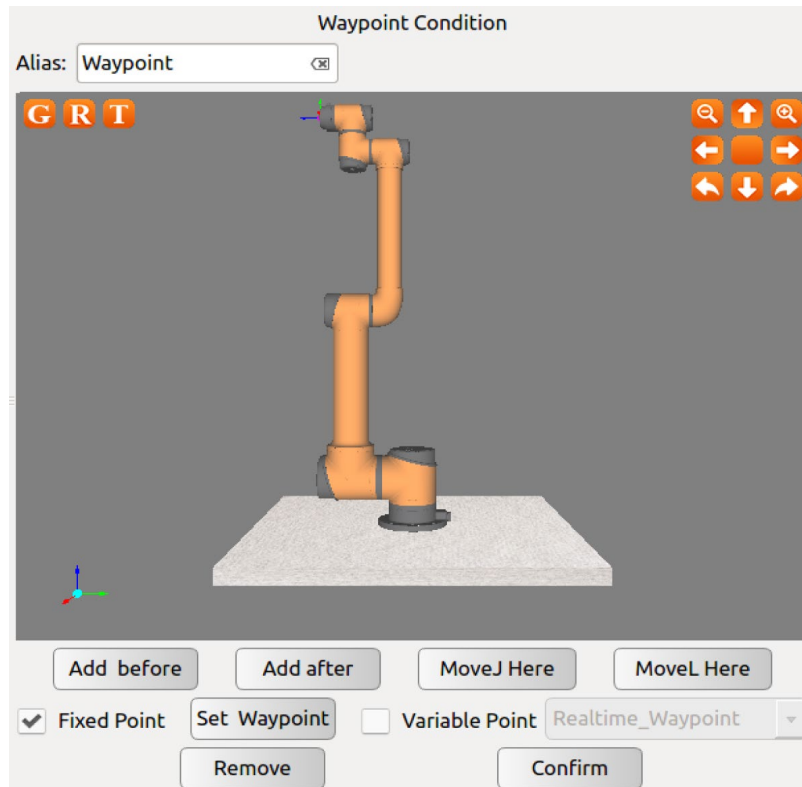

Figure 11-49 Waypoint command

- Click the **Alias** to the right of the input box to modify the command name.
- Waypoint can only be added after the Move command.
- Click **Add before** to add a new waypoint in front of the waypoint.
- Click **Add after** to add a new waypoint after the waypoint.
- Clicking **Move here** will allow the robot to move to the current waypoint and be valid for real robots.
- You can choose to **moveJ here** or **moveL here**.
- Click **Remove** to remove this waypoint.
- Click **Set Waypoint** to set the position pose from the waypoint. After clicking to set the waypoint, the panel automatically switches to **robot teaching**. The user can move the end of the robot to the new waypoint and click the confirm button in the lower right corner.
- Click **confirm** to save the waypoint status configuration. At this time, the pop-up window will pop up and the display condition has been saved.

Variable waypoint

Select the variable point at the waypoint condition interface. After confirming, this waypoint is the waypoint set in the variable setting. When the waypoint in the variable is changed, all the waypoints in the project file will be changed. This function can be changed in batches. The parameters of the waypoints save programming time. The variable point corresponds to the type in the variable configuration as the pose variable.

Relative waypoint

The user performs motion control of the robot arm or end tool coordinates by a position or attitude offset relative to the selected coordinate system.



The screenshot shows a control panel for relative offset. It includes a checked checkbox labeled 'Relative Offset', two unit selection buttons: 'Pos(m)' (highlighted) and 'Rot(deg)', and a 'Coord' dropdown menu currently set to 'Base'. Below these are three input fields for X, Y, and Z coordinates, each containing the value '0' and a clear button (X).

Figure 11-50 relative offset

Coordinate System

The coordinate system can be selected based on the Base coordinate system and the user-defined plane coordinate system (plane). For the user-defined plane coordinate system (plane) calibration, see 10.4.3 Coordinate System Calibration Summary.

11.6 Basic Command & Condition Tabs

【Command】 and 【Condition】 are two important parts in the programming environment. 【Command】 is used for writing and adding commands. 【Condition】 is used for configuring the selected command status. These two tabs usually are used in the same time, so this section introduces them together.

This section mainly introduces the meaning and the usage of commands. Only known the usage of commands, we can program successfully and completely.

11.6.1 Loop

Loop is a loop command. The underlying program commands are either looped infinitely, a certain number of times or as long as the given condition is true.

- Clicking 【Alias】 to the right of the blank interface will pop up the input box. You can modify the command name.
- Choose 【Loop always】 to loop infinitely.
- Choose 【Loop_Times】 to set loop frequency and exit the loop when reach loop times.
- Choose 【Loop condition】 to set loop expression. When expression is established, enter the loop, otherwise, exit loop. Click 【Clear】 to clear the expression.
- Click 【Confirm】 to confirm and save the configurations.

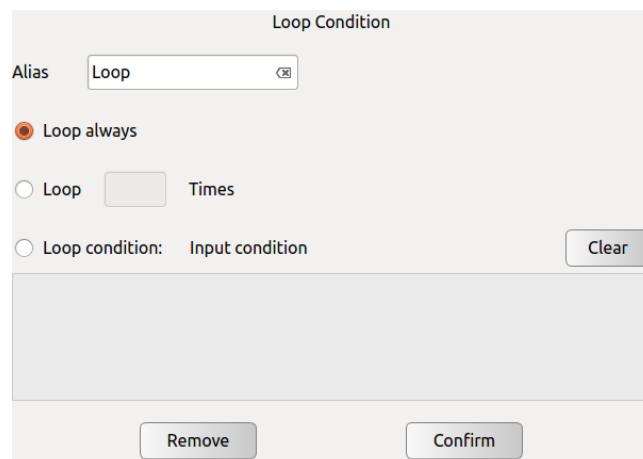

Figure 11-51 Loop

11.6.2 Break

Break command is used to jump out of a loop when Break condition is satisfied.

- Clicking **【Alias】** to the right of the blank interface will pop up the input box. You can modify the command name.
- The gramma of Break should be formal. Break can only be used inside Loop. Before Break command, there must be an If command. When If condition is true, Break will be executed and jump out of the loop. Otherwise, an error message will pop up.
- Click **【Remove】** to delete the Break command.

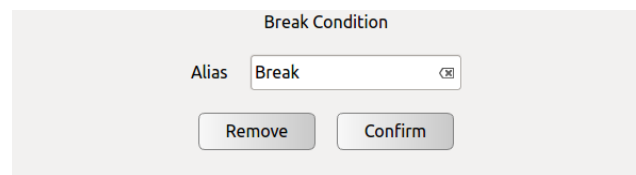

Figure 11-52 Break

11.6.3 Continue

Continue command is used to terminate a Loop for one time. Note the difference between **Continue** and **Break**, Break jump out of whole loop and don't enter again. **Continue** jump out of loop for one time and enter the loop in next time.

- Clicking **【Alias】** to the right of the blank interface will pop up the input box. You can modify the command name.
- The gramma of Continue should be formal. Continue can only be used inside Loop and there must have an If command before Continue. When condition in If is satisfied, then execute Continue to jump out of the loop for one time. Otherwise, an error message will pop up.
- Click **【Remove】** to delete the Continue command.

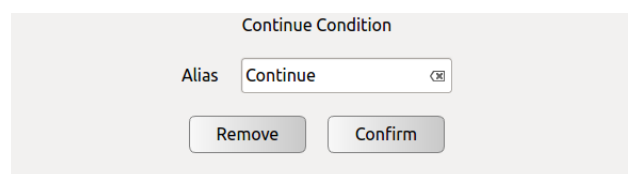
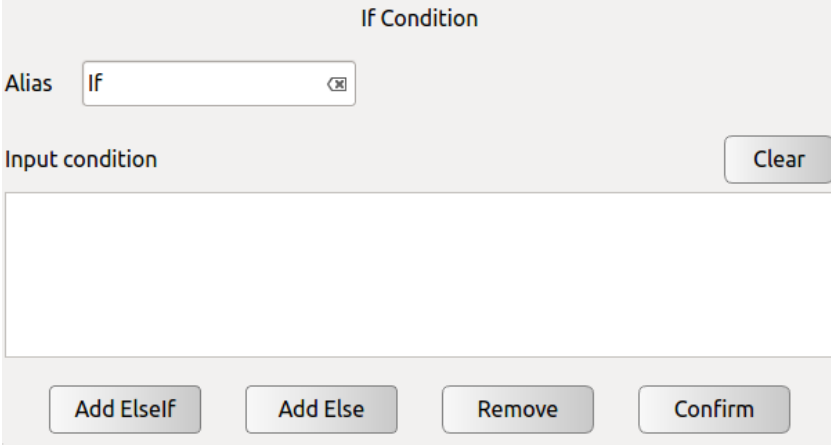

Figure 11-53 Continue

11.6.4 If...else

If...else command is used to operate different subprograms based on different conditions.

- Clicking **【Alias】** to the right of the blank interface will pop up the input box. You can modify the command name.
- Click **【Input condition】** to input condition expression based on C language arithmetic rule, as shown in Figure 11.18(b). If the condition is evaluated to be true, the program inside this If is executed. If the expression evaluates to be false, the following Else If or Else statements will be executed.
- Click **【Clear】** to delete an expression.
- Click **【Add Else】** to add an Else node to make an If...Else statement. One **【If】** command can only add one Else.
- Click **【Add ElseIf】** to add an ElseIf node. One **【If】** command can add multiple Else If nodes.
- Click **【Remove】** to delete **【If】** command. All ElseIf nodes and Else nodes will be deleted together.
- Click **【Confirm】** to confirm and save the configurations.



The screenshot shows a dialog box titled "If Condition". It contains an "Alias" field with a dropdown menu showing "If" and a clear button. Below that is an "Input condition" field with a "Clear" button. At the bottom, there are four buttons: "Add Elseif", "Add Else", "Remove", and "Confirm".

Figure 11-54 If...Else

11.6.5 Switch...Case...Default

Switch...Case...Default is a condition selection command that runs different case program branches by judging conditions.

- Click the blank space on the right of **【Alias】** , It will pop up the input box, and user can modify the command name.
- Click the blank space on the right of **【Input condition】** , it will pop up the input box for input the conditional expression. The expression operation follows the Lua language operation rules. When you run the Switch command, the program will calculate the value of the Input condition expression and compare with the condition value of the following Case statement. If they are equal, execute the following program segment in the Case statement. If there is no Case value that satisfies the condition, then execute Default corresponding program segment.

Note: To determine the authenticity, users can only use true / false, can not use 1/0 instead.

- Click **【Clear】** to clear the expression.
- Click **【Add Case】** to add a Case node and form a Switch ... Case combination with the current Switch node. A Switch can add more than one Case.
- Click **【Add Default】** to add a Default node. One Switch can only add one Default.
- Click **【Remove】** to delete the selected Switch, and the corresponding Case and Default of this switch will also be deleted.
- Click **【Confirm】** to confirm the configurations and save.

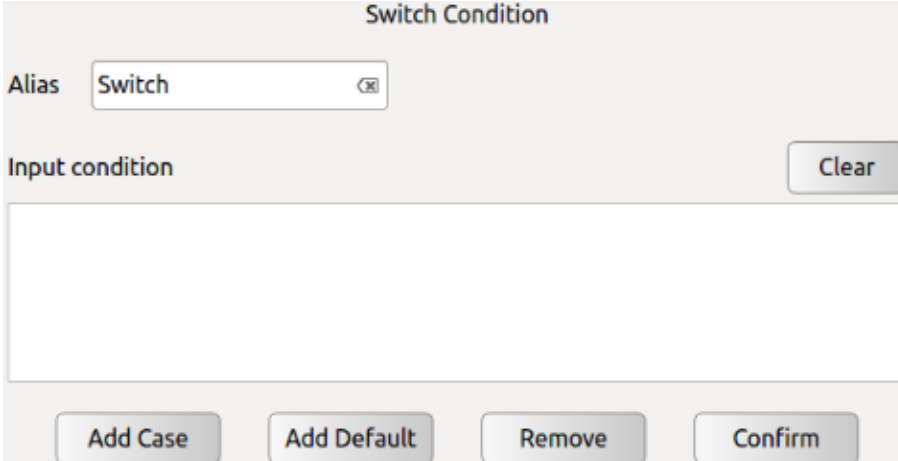

The screenshot shows a dialog box titled "Switch Condition". It features an "Alias" label next to a text input field containing the word "Switch". To the right of this field is a small "x" icon for clearing the text. Below the "Alias" field is an "Input condition" label next to a larger, empty text area. To the right of this text area is a "Clear" button. At the bottom of the dialog, there are four buttons arranged horizontally: "Add Case", "Add Default", "Remove", and "Confirm".

Figure 11-55 switch...case...default command

11.6.6 Set

- Clicking **【Alias】** to the right of the blank interface will pop up the input box. You can modify the command name.
- Choose **【Tool Param-Set Tcp Center】** : Set the deviation of current tool payload, which is relative to end flange center in XYZ three directions.
- Choose **【Collision Class】** : Set the collision detection level.
- Choose **【IO type】** : Choose IO type to set the DO/AO state.
- Choose **【Variable】** : Choose a variable on the below drop-down list. Input an expression to assign a value to the choose variable, which should follow C language arithmetic rule. Click **【Clear】** to clear expression.
- Click **【Remove】** to remove Set command.
- Click **【Confirm】** to confirm and save the configurations.

Figure 11-56 Set Command



1. In the actual operation, inaccuracy settings will cause different errors including wrong stop.
2. If these settings are wrong, the manipulator and control box will not function correctly and may become dangerous to people or equipment around them.

11.6.7 Wait

Wait command is used to set waiting time or digital input signals.

- Clicking **【Alias】** to the right of the blank interface will pop up the input box. You can modify the command name.
- Choose **【Wait Time】** to set wait time by users.
- Click **【Wait Condition】** to set wait mode by inputting expression.
- Click **【Clear】** to clear the wait condition.
- Click **【Confirm】** to confirm and save the wait condition.
- Click **【Remove】** to delete a wait command.

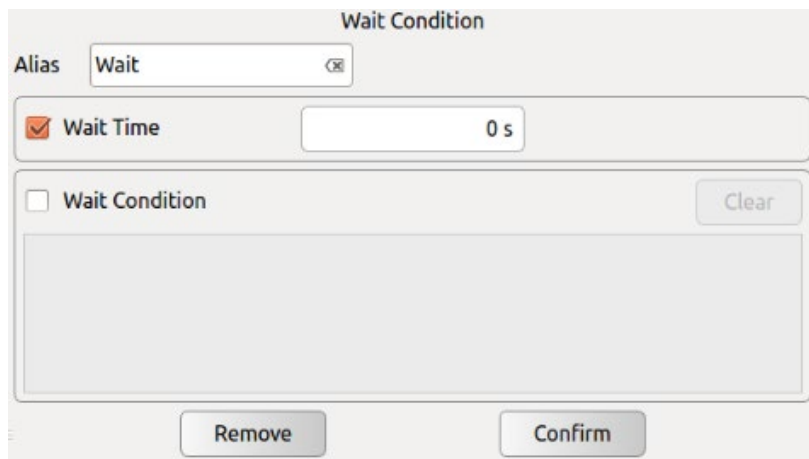

Figure 11-57 Wait Command

11.6.8 Line Comment

Line Comment is a command that explains the following program by line comment.

- Clicking **【Alias】** to the right of the blank interface will pop up the input box. You can modify the command name.
- Click **【Comment】** to input text to explain the following block.
- Click **【Remove】** to delete the selected Line Comment.
- Click **【Confirm】** to confirm the configurations and save.



Figure 11-58 Line Comment

11.6.9 Block Comment

Block Comment is a command that explains the following block by line comment.

- Clicking **【Alias】** to the right of the blank interface will pop up the input box. You can modify the command name.
- Click **【Comment】** to input text to explain the following block.
- Click **【Remove】** to delete the selected Block_Comment.
- Click **【Confirm】** to confirm the configurations and save.



Figure 11-59 Block Comment

11.6.10 Goto

The Goto command will interrupt the robot's current task and move to another task.

The robot motion is seen as below:

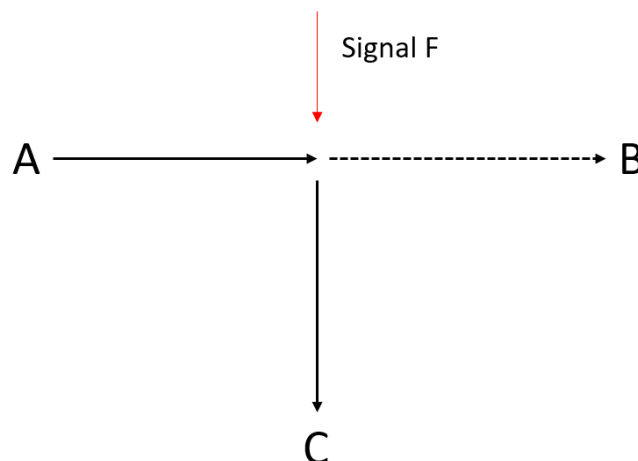

Figure 11-60 Goto Command

The robot is programmed to move from A to B, yet it receives a signal F on its way to B, it stops moving towards B and goes immediately to C.

GOTO command is designed to interrupt the current movement. It must be used in the thread program. A demo project is seen as below:

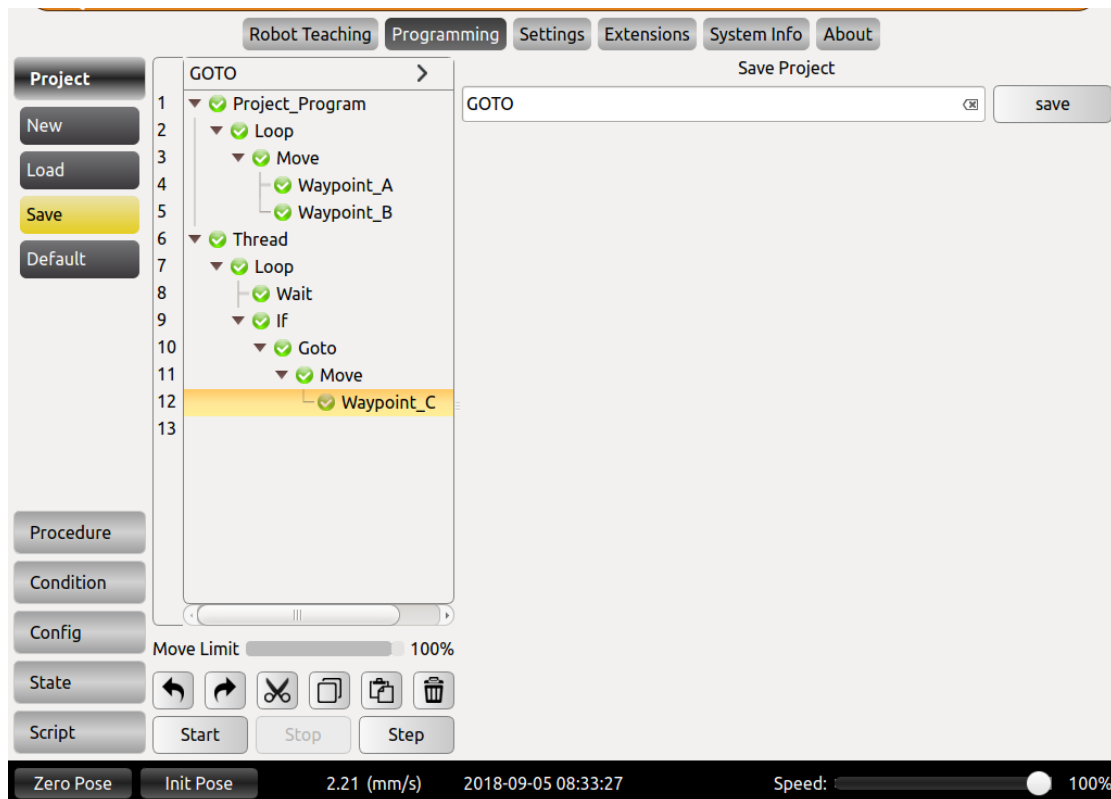

Figure 11-61 Insert Goto Command

The "If" command is set to "DI==0" or any other input signals. "Wait" command of at least 0.01s is necessary to ensure the GOTO to work, lack of it may cause unpredictable problems and stop the robot.

11.6.11 Message

Message is a message pop-up command that pops up the message window to convey the status information to the user.

- Click **【Alias】** input box on the right to modify the command name.
- Click the **【Message Type】** drop-down menu to select the information types, corresponding to Information, Warning, Critical, and the corresponding window icons of the three types of information are different.
- Click **【Message】** , the blank space on the right will pop up the input box You can enter text to convey the status information.
- After the message box pops up, the robot will wait for the user/operator to click the Confirm button in order to continue running the program.
- Click **【Stop project when this message box pops up】** , the project will stop automatically when the information window pops up.
- Click **【Remove】** to delete the selected message.
- Click **【Confirm】** to confirm the configurations and save.

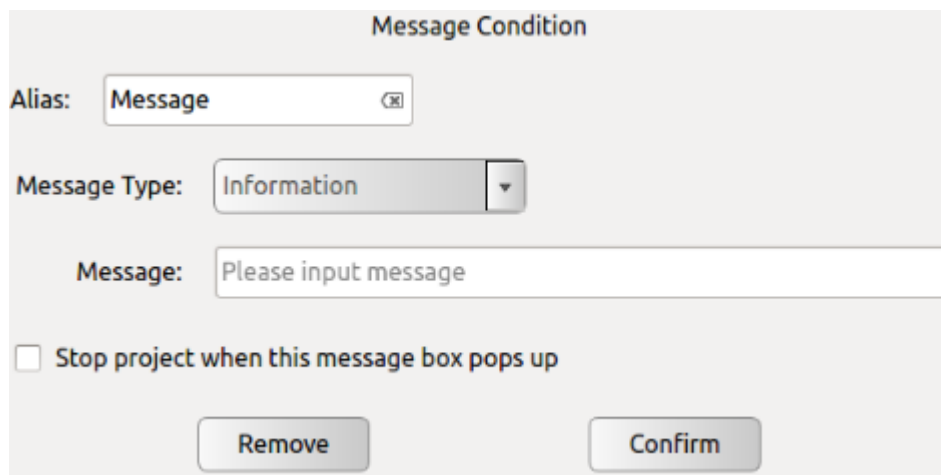

Figure 11-62 Message Command

11.6.12 Empty

Empty is an empty command, and an empty command is inserted to make it easier to space out program lines for operations such as pasting.

- Click  to delete the selected Empty.

11.7 Advanced Command & Condition Tabs

11.7.1 Thread

Thread is a multi-threaded control command. In the **Thread** block, there must be a **Loop** command. In the loop, user can achieve the parallel control with the main program.

- Click **【Alias】** input box on the right to modify the command name.
- Click **【Remove】** to delete the selected Thread.
- Click **【Confirm】** to confirm the configurations and save.

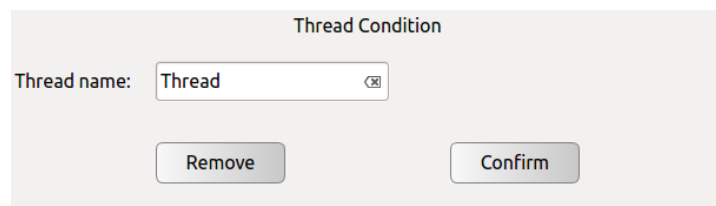

Figure 11-63 Thread Command

Note:

It is recommended to avoid the use of multi-threaded. If you must use multiple threads, be aware of the parallel logic and timing of the main and auxiliary threads.

It is recommended at most three threads, including the main and running at the same time.

Procedure can not be inserted into the process of the Thread program.

11.7.2 Script

Script is a script editing command. In Script, you can choose to add Line Script and Script File.

Note: Procedure can not be inserted into the process of the Thread program.

- Click **【Alias】** input box on the right to modify the command name.
- Click **【Line Script】** to add a Line Script button. You can enter a line of script control commands in the input box below.

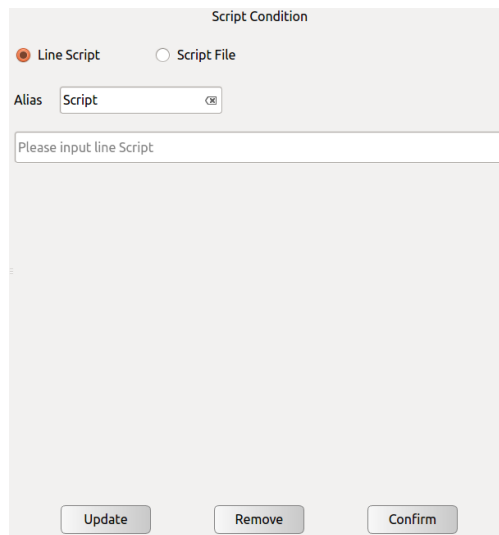

Figure 11-64 Script – Line script Command

- Click **【Script File】** to add Script File button. You can choose to load Script File.

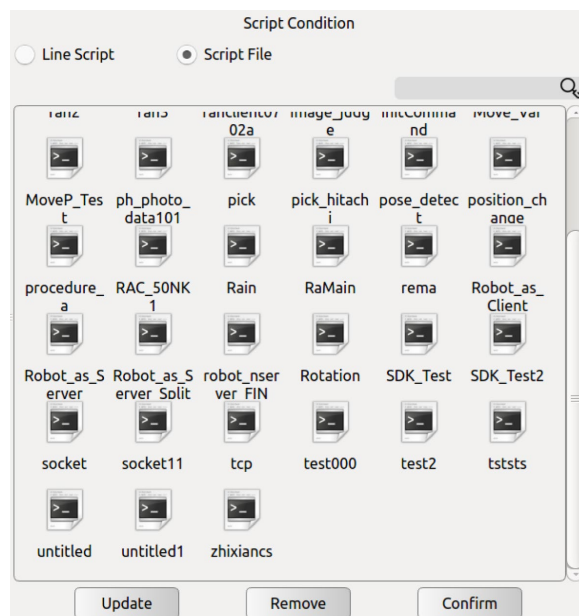

Figure 11-65 Script – Script File Command

The script files can copy to the below folder:

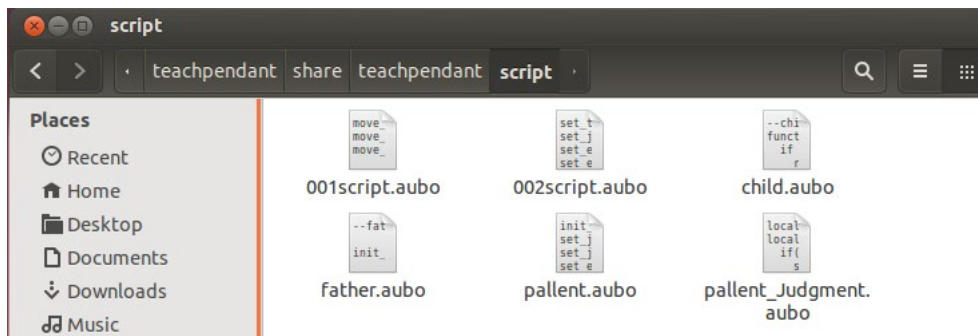

Figure 11-66 Script – Script File Command

- Click **【Update】** as the file update button to retrieve the current file save directory and update the display file changes.
- Click **【Remove】** to delete the selected Thread.
- Click **【Confirm】** to confirm configuration and save.□

11.7.3 Offline Record

The Offline Record command can import the track file which was generated via offline programming software into the online programming.

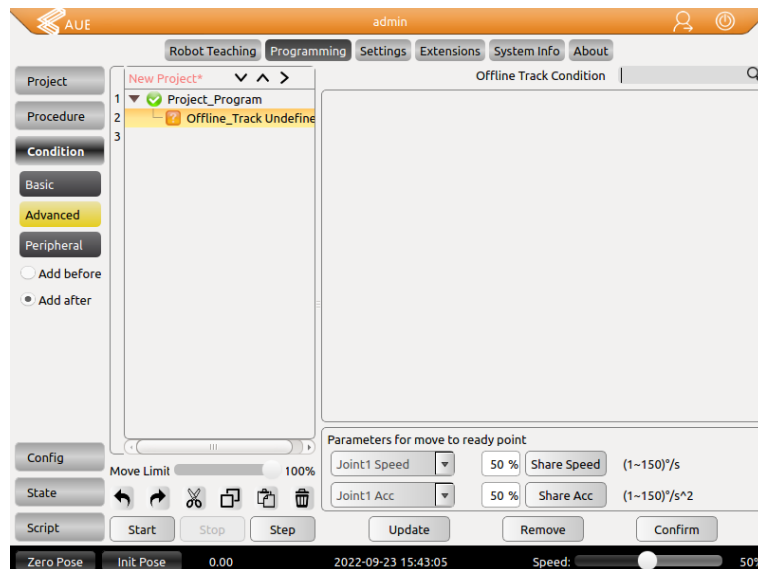

Figure 11-67 Offline Track Command

- Select the offline file and click **【confirm】** to save.
- The bottom of the interface can set the speed and acceleration of each joint when the robot moves to the ready point. After modification, click the **【confirm】** to save.
- The imported trace file format must include six joint angles in each line, and the unit is radian.
- The imported trace file suffix should end with "offt."
- The import file needs to be copied to the folder to be displayed in AUBOPE software interface, as shown in the following figure:

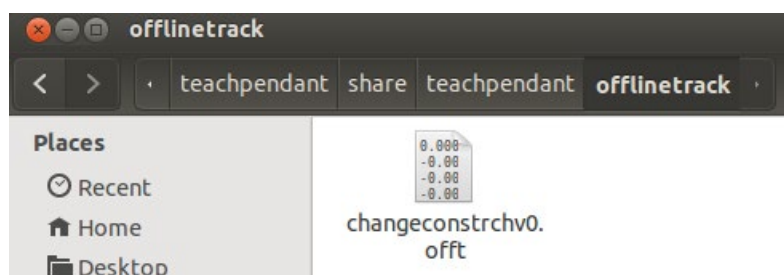

Figure 11- 68 Import offline file to this folder

11.8 Record Track

The recorded trajectory enables the recording of the trajectory of the robot arm over a period and is applied to the online programming environment.

Track record can record the movement track of the robot for a certain period and used in online programming.

New track: Click **Start** to record the movement track of the robot, click **Finish** to stop the recording, enter the track name, click **Save** to finish.

Track replay: Click the **Track** to select, click **Load**, then press and hold Ready, wait it to reach its original position, and then click **Play** to review the track.

Track pause: Click **Stop** to pause the track replay.

Edit track: click **Cut Before** to remove the track before selected position, click **Cut After** to remove the track after selected position.

Interval: The track recording time unit is 100ms for each waypoint. The interval time means how much time to play the 100ms. For example, if the interval time is set to 50ms, the track will be played at twice the speed. If it is set to 200ms, 0.5 times slower.

When the track is played back, the track progress is displayed through the slider and the progress bar, and the user can also manually drag the progress bar to operate the track.

Click on the cut head to delete the track before the slider is located. Click on the cut tail to delete the track after the slider is located.

The time interval of the track record is 2 seconds ~ 5 minutes.

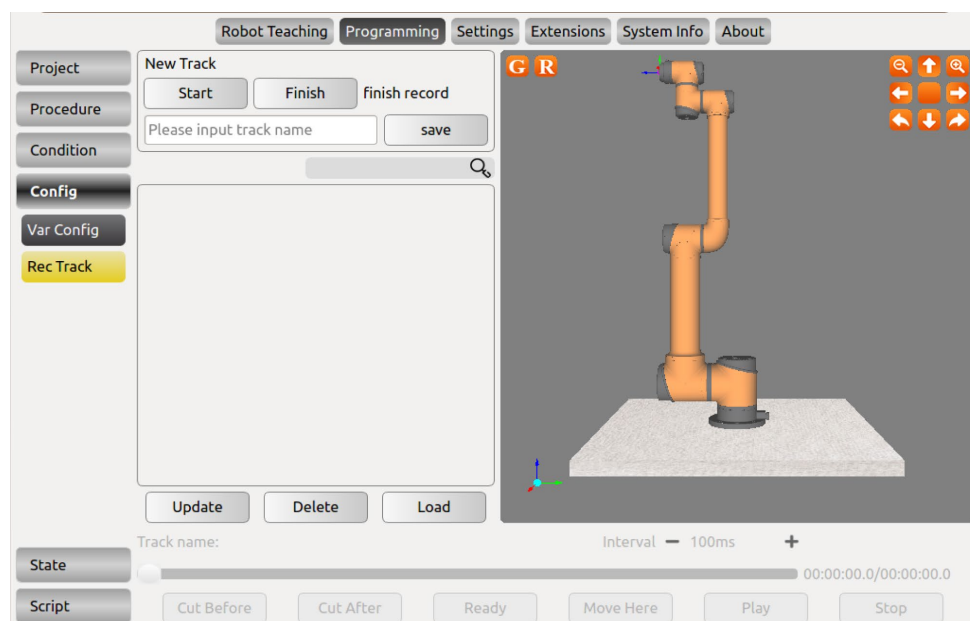

Figure 11-69 Record Track page

Calling Record Track Command:

- Create or open a project file and select Advanced Conditions in the Toolbar.
- Click Record Track in the Properties window, and click Record Track in the project logic.
- Select the track icon in the property window on the right, and click the Conform button to load the track record into the project logic.
- The parameter input box on the lower side of the interface to run to the preparation point can set the speed and acceleration of each joint when the manipulator moves to the preparation point. After modification, please click the Confirm button.
- Click the Update to File Update button to retrieve the current file save directory and update the display file changes.
- Click Remove to delete the Track_Record command at the project logic.

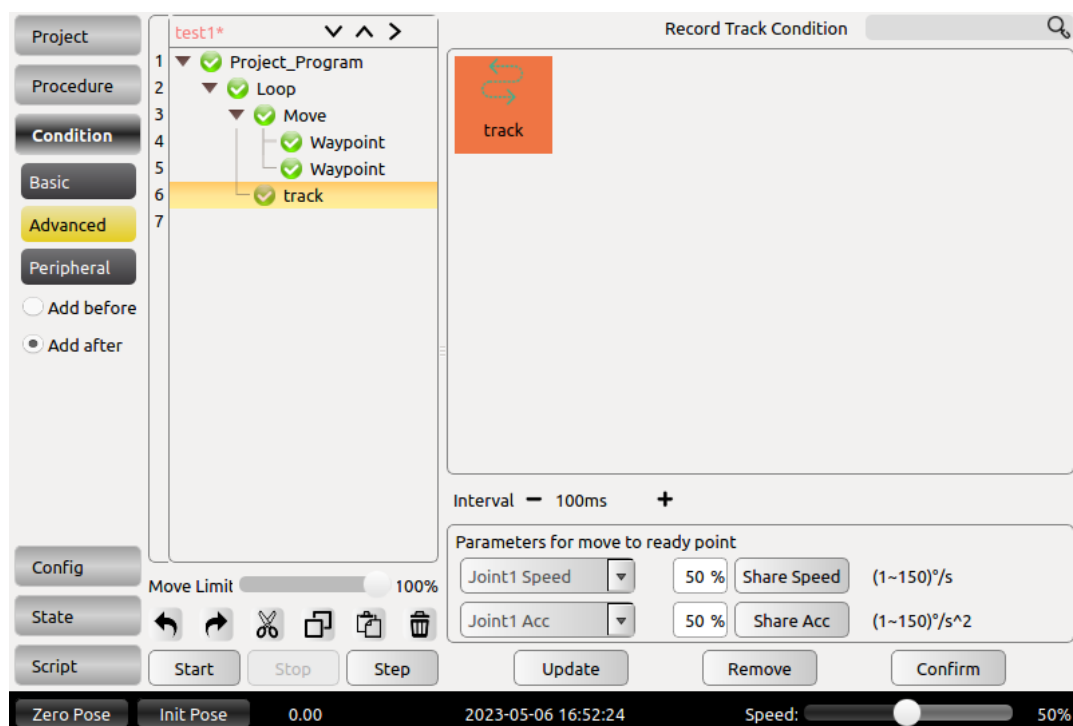

Figure 11-70 Record Track command

- Add variables: Choose a variable type, there will be corresponding type of input options box in **Variable value** option. Input variable name and value, click **【Add】** . If new variable has been added, it will be shown on the bottom of the list. Note: Variable names must be unique and can only contain numbers, letters and underscores. Otherwise, it won't be saved and pop-up prompts.
- Modify variables: Choose a variable in table and all information will be shown in operating area below. Users can click **【modify】** to change the name and value of variable. Note: Variable type can't be changed, otherwise will pop up silent failure. If the variable has been used in existing project file, it won't prompt that this variable name condition is undefined until reload the project. After changing variable name, users must reload the project before operation in case unknown errors occur.
- Delete variables: Choose a variable in table and click **【Delete】** to delete this variable. Note: Similar with modify variable, If the variable has been used in existing project file, it will not prompt that this variable condition is undefined until reload the project. After deleting variable, users must reload the project before operation in case unknown errors occur.

11.10 Timer

11.10.1 Insert Timer

The Timer command is a timed command that measures the running time of nodes in the project file.

- Click the blank input box on the right side of the nickname to modify the command name.
- Click Remove to remove this selected line comment command.
- Click OK to confirm the status configuration and save.

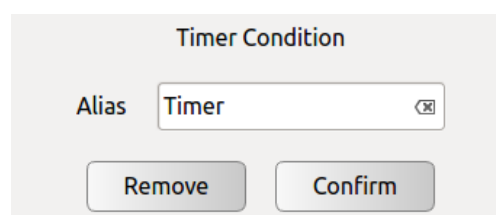

Figure 11- 72 Timer Command

11.10.2 Timer State Display

The menu bar selects online programming, and the toolbar selects the state-timer to view the timer state display.

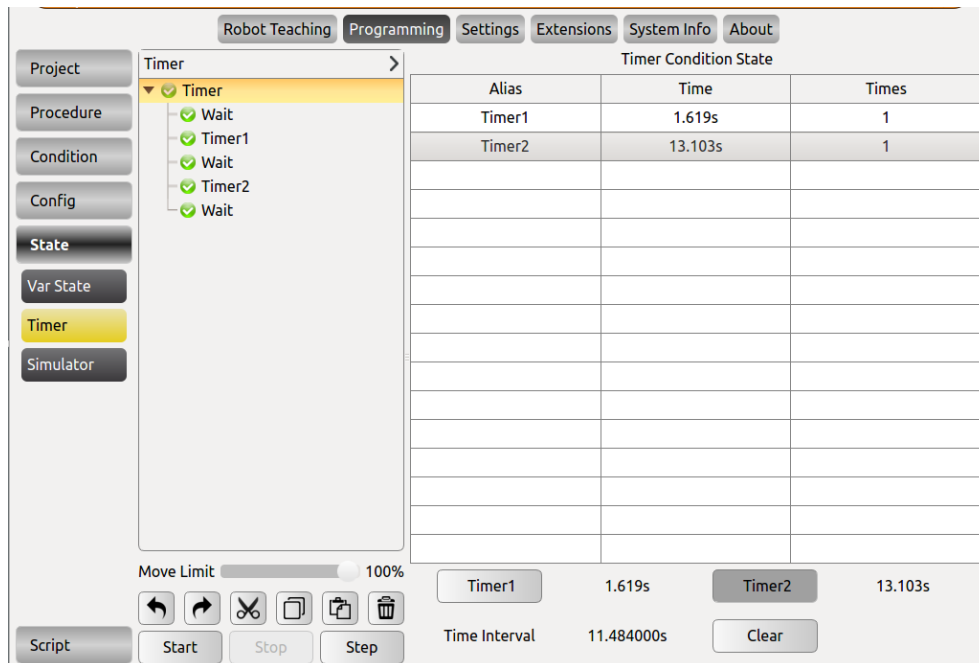

Figure 11-73 Timer

- The nickname corresponds to the command name in the project file.
- Time is the time it takes for the program start point to run to this Timer command.
- Times indicates the number of times this Timer command was executed in the program file.
- Timer1 and Timer2 are the corresponding time displayed when a Timer command is selected.
- The time interval is the time interval between the selected Timer and the last selected Timer.

Note: The display of timer1 and timer2 has a relationship with the order of the condition names in the click list. The gray color of the button is subject to the display order of the time name.

11.11 Simulation Model

The simulation model is a function under Programming. It displays two parts, the upper part is robot 3D simulation, and the lower part displays robot movement parameters. Users can pause or stop the robot, and also view robot's log information.

Robot 3D simulation would be in sync with the real robot in real-time, and the movement parameters are displayed under the 3D model, including the position parameter XYZ and the rotate parameters: RX RY RZ.

Users can check "Show track" and see the end of the track in the simulation window. Users can also set the Track duration to specify the track display time.

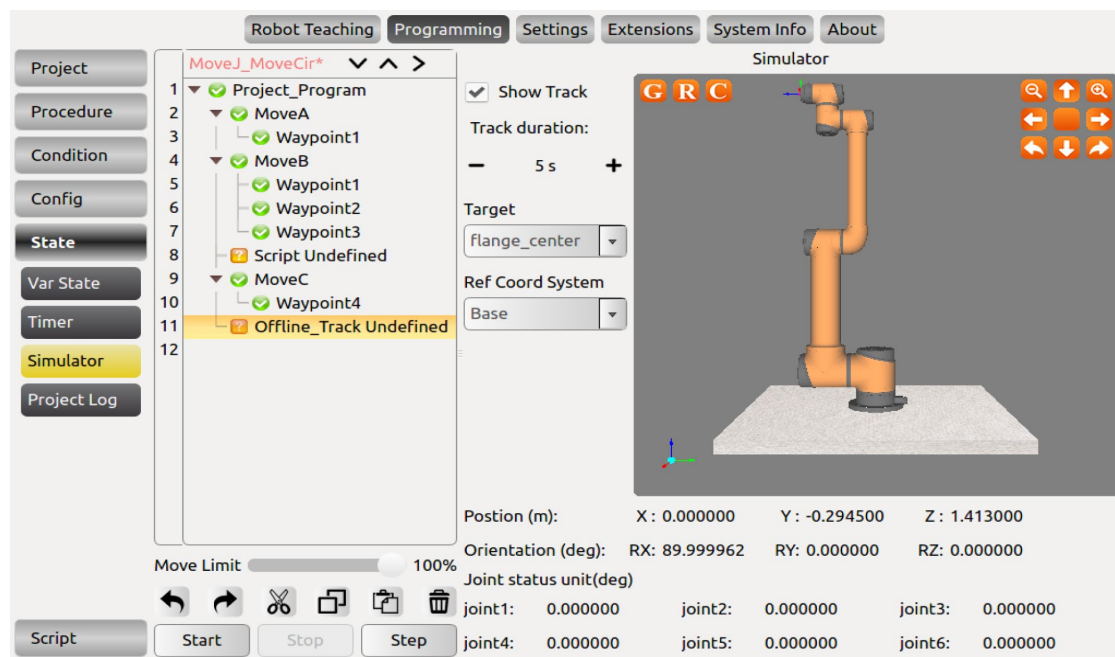

Figure 11-74 Simulation model

11.12 Project Log

The project log can display the real-time project running status. When the user click "Start" to run a program, it will automatically switch to the project log interface.

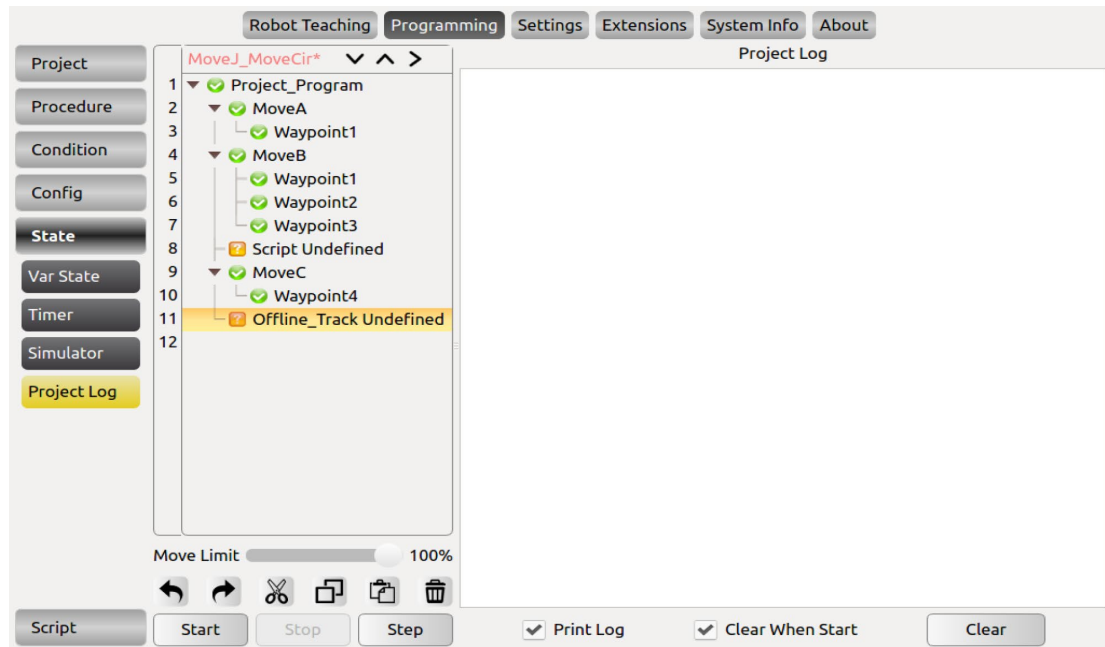

Figure 11-75 Simulation model

11.13 Scripts File Configuration

Online programming function can help the user to new, edit, load and save scripts. Note: scripts should comply with LUA syntax, otherwise cannot be saved.

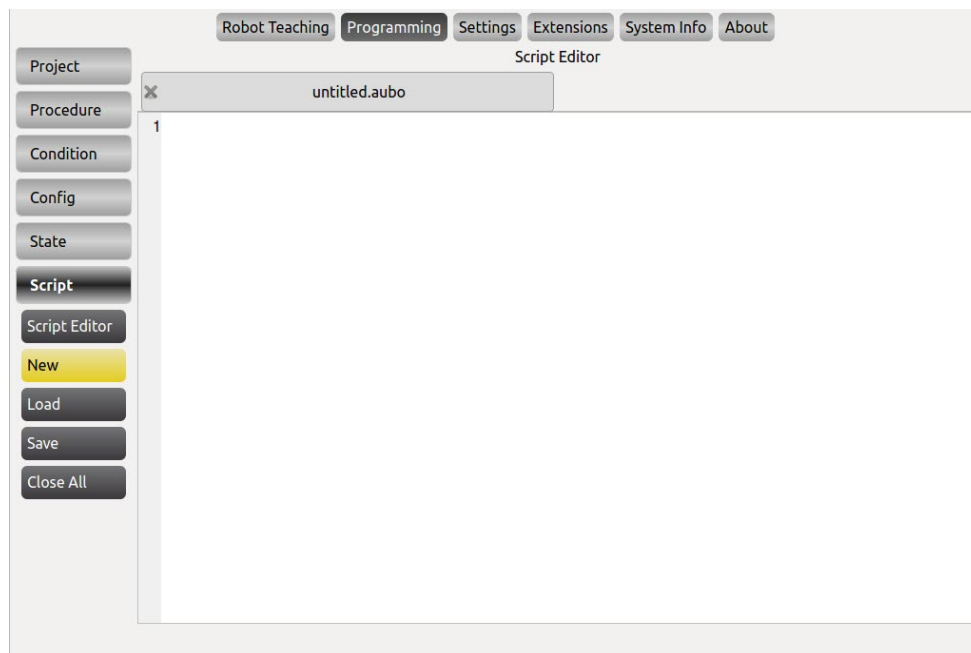

Figure 11-76 script file editor

Appendix

A. Glossary

Category 0 stop: Robot motion is stopped by immediate removal of power to the robot. It is an uncontrolled stop, where the robot can deviate from the programmed path as each joint brake as fast as possible. This protective stop is used if a safety-related limit is exceeded or in case of a fault in the safety related parts of the control system. For more information, see EN ISO13850:2008 or IEC60204-1:2006.

Category 1 stop: Robot motion is stopped with power available to the robot to achieve the stop and then removal of power when the stop is achieved. It is a controlled stop, where the robot will continue along the programmed path. Power is removed after one second or as soon as the robot stands still. For more information, see EN ISO13850:2008 or IEC60204-1:2006.

Category 2 stop: A controlled stop with power left available to the robot. The robot can use up to one second to stop all motion. The safety-related control system monitors that the robot stays at the stop position. For more information, see IEC 60204-1:2006.

Diagnostic coverage (DC): is a measure of the effectiveness of the diagnostics implemented to achieve the rated performance level. For more information, see EN ISO13849-1:2008.

Integrator: The integrator is the entity that designs the final robot installation. The integrator is responsible for making the final risk assessment and must ensure that the final installation complies with local laws and regulations.

MTTFd: The Mean time to dangerous failure (MTTFd) is a value based on calculations and tests used to achieve the rated performance level. For more information, see EN ISO13849-1:2008.

Risk assessment: A risk assessment is the overall process of identifying all risks and reducing them to an appropriate level. A risk assessment should be documented. Consult ISO 12100 for further information.

Performance Level: A Performance Level (PL) is a discrete level used to specify the ability of safety-related parts of control systems to perform a safety function under foreseeable conditions. PLd is the second highest reliability classification, meaning that the safety function is extremely reliable. For more information, see EN ISO13849-1:2008.

B. CERTIFICATION

The AUBO i series of robots have passed the inspection and evaluation of the company's quality management system and sample type tests to confirm that the product meets specific requirements, and has the ability to continuously and stably produce products meeting the requirements of the standard, and has given written proof. described as follows:

The AUBO-i series of robots have passed the testing and certification of many international third-party organizations, and obtained EU CE certification, North American certification. The product safety has reached the international leading level.



AUBO-i16 robots are certified by SGS and passed the EU CE certification. The product complies with all relevant requirements of the EU CE Directive:

Machinery Directive (MD) 2006/42/EC

Electromagnetic compatibility (EMC) 2014/30/EU

EN ISO 10218-1:2011

EN ISO 12100:2010

EN ISO 13849-1:2015

EN 60204-1:2018

EN 61000-6-2:2019

EN 61000-6-4:2019



AUBO-i16 robots are certified by TÜV SÜD and have been certified in North America to meet all relevant North American certification requirements:

UL 1740: 2018

CAN/CSA-Z434-14/R:2019

Supplemented by

ANISI RIA R15.06-2012

NFPA 79:2018

C. Guideline

Robot design reference to the following standards.

<i>Standard</i>	<i>Definition</i>
2006/42/EC:2006	<p>Machinery Directive:</p> <p>Directive 2006/42/EC of the European Parliament and of the Council of 17 May 2006 on machinery, and amending Directive 95/16/EC (recast)</p>
2004/108/EC:2004	<p>EMC Directive:</p> <p>Directive 2004/108/EC of the European Parliament and of the Council of 15 December 2004 on the approximation of the laws of the Member States relating to electromagnetic compatibility and repealing Directive 89/336/EEC</p>
EN ISO 13850:2008	<p>Safety of machinery:</p> <p>Emergency stop - Principles for design</p>
EN ISO 13849-1:2008	<p>Safety of machinery:</p> <p>Safety-related parts of control systems - Part 1: General principles of design</p>
EN ISO 13849-2:2012	<p>Safety of machinery:</p> <p>Safety-related parts of control systems - Part 2: Validation</p>
EN ISO 12100:2010	<p>Safety of machinery:</p> <p>General principles of design, risk assessment and risk reduction</p>
EN ISO 10218-1:2011	<p>Industrial robots:</p> <p>Safety</p> <p>Note: Content equivalent to ANSI/RIA R.15.06-2012, Part 1</p>
ISO/TS 15066: 2016	<p>Safety requirements for collaborative industrial robot</p> <p>Robots and robotic devices —Collaborative robots</p>

D. Technical Specification

Robot Model	AUBO-i16		
Weight	38 kg		
Payload	16 kg		
Maximum working radius	967.5 mm		
Joint ranges	joint1: -360° ~ +360° joint2/joint3: -175°~175° joint4/joint5: (default) -175°~175°, (option)-360° ~ +360° joint6: -360° ~ +360°		
Joint speed	joint1/joint2/joint4/joint5/joint6: 178°/s joint3: 267°/s		
Tool linear speed	≤ 3.0m/s		
Repeatability	± 0.03 mm		
Degrees of freedom	6 rotating joints		
IP protection level	Manipulator: IP 54 Control box/teach pendant: IP 43		
Control box type	AUBO-CB-M2000 / AUBO-CB-M2900		
Control box size (L * W * H)	380mm*350mm*265mm		
Control box weight	15 kg		
I / O ports		Standard control box	End-effector
	DI	16 (General) 16 (Safety)	4 (Configurable)
	DO	16 (General) 16 (Safety)	4 (Configurable)
	AI	4	2
	AO	4	-

I / O power supply	24V 3A in the control box (parameters are subject to actual data), 0V/12V/24V 0.8A in tool
Communication	Ethernet、 ModBus-RTU/TCP、 Profinet (Optional)
Interface	SDK (support C\C++\C#\Lua\Python), support ROS, API
Programming	AUBOPE graphical user interface on 12.5-inches touchscreen
Power consumption	Approx. 600W using a typical program
Collaboration operation	Collaborative operation according to ISO 10218-1:2011
Working Temperature	Robot can work in a temperature range of 0-50°C
Transport and storage temperature	-25 °C ~ 55 °C
Relative humidity	90% relative humidity (non-condensing)
Power supply	100-240 VAC, 50-60 Hz
Cable	Manipulator cable: 5m Teach pendant cable: 4m Power cable: 5m

E. Payload

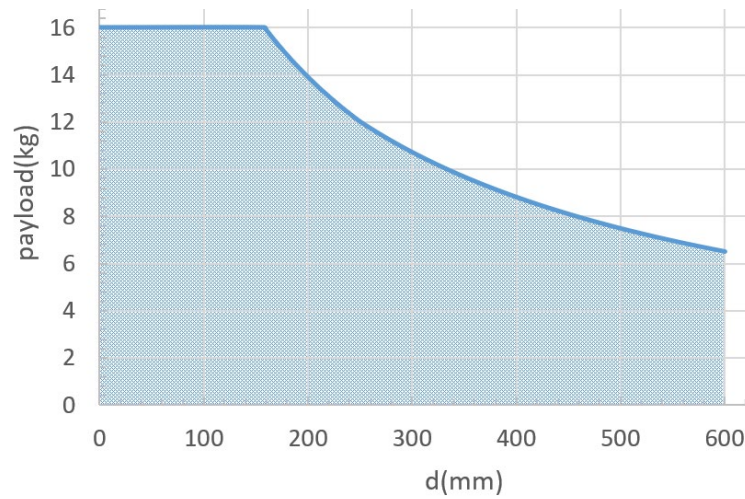

Payload centroid range has shown above, in which x-axis represent the center of gravity offset which is the distance between end-effector flange focus and tool focus.



1. The load conditions should within the range shown in the figure.
2. The payload shown in figure represent maximum load capacity. Shall not overload in any case.
3. Overload may cause damage to the machine's internal parts.

F. Alarm Information & Description of General Problem

Type	Information	Description	Possible error	Solution
Interfaceboard	Diagnosis info: Arm canbus error, code: 0x%1	0x01: base 0x02: Joint 1 0x04: Joint 2 0x08: Joint 3 0x10: Joint 4 0x20: Joint 5 0x40: Joint 6 0x80: Tool side	can communication error	Check CAN bus connection between modules
Interfaceboard	Diagnosis info: Remote Halt	Prompt message	/	/
Interfaceboard	Diagnosis info: Remote Emergency Stop	Prompt message	/	/
Interfaceboard	Diagnosis info: Enter force control mode, disable UI	Prompt message	/	/
Interfaceboard	Diagnosis info: Exit Force Control	Prompt message	/	/
Interfaceboard	Diagnosis info: Enter linkage slave mode, disable UI	Prompt message (press the teach pendant enable button on the control box panel)	/	/

Type	Information	Description	Possible error	Solution
Interfaceboard	Diagnosis info: Enter linkage master mode	Prompt message (Pop-up the teach pendant enable button on the control box panel)	/	/
Interfaceboard	Diagnosis info: Soft Emergency	Prompt message	/	/
Interfaceboard	Diagnosis info: Arm Power Off	Prompt message	Contact disconnect	Check if there is a problem with the contactor
Interfaceboard	Diagnosis info: Mounting Pose Changed	Prompt message	Confirm the robot installation. If it is not confirmed, it may cause a crash	Confirm the robot installation
Interfaceboard	Diagnosis info: Joint angle exceeds limit	Fault	Arm cannot be started	Contact after sales for reset
Interfaceboard	Diagnosis info: Encoder Error	Hardware malfunction	Arm cannot be powered on, and the hardware of the joint module is faulty	Hardware problems, replace or repair the joint circuit board
Interfaceboard	Diagnosis info: Encoder Lines Error	Hardware malfunction	Arm cannot be powered on, and the hardware of the joint module is faulty	Hardware problems, replace or repair the joint circuit board

Type	Information	Description	Possible error	Solution
Interfaceboard	Diagnosis info: Singularity Overspeed	Prompt message	Stop the project immediately	Contact after-sales to confirm whether it is a software or hardware problem
Interfaceboard	Diagnosis info: Current Alarm	Fault Information	The arm cannot be activated	Contact after sales
Toolio Error	Toolio Error	Fault Information	The arm cannot be activated	Contact after sales
Teachpendant	SDK Socket Disconnected. Need to Restart	Software failure	Teach pendant software restart	Update the latest version software
Robot Controller	Joint tracking is lost	Prompt message	The arm is powered off	Update the latest version software
Robot Controller	No real robot found, disable IO settings	Prompt message	Unable to connect to real arm	Check network configuration, initialize network if necessary
Robot Controller	Mac communication with interface board failed, disable IO settings	Prompt message	Unable to connect to real arm	1. Check network configuration, initialize network if necessary 2. Check if the interface board or mainboard is damaged
Teachpendant	Load script file fail, please check the log	Prompt message	Unable to run script file	Check script content
Teachpendant	Load Script File Fail, function/loop/while/for/if/switch condition is too long, please split too long conditions	Prompt message	/	/

Type	Information	Description	Possible error	Solution
Teachpendant	Call SDK interface error, please check the log	Prompt message	motion function not available	Check the log, it may be caused by the wrong configuration of the motion function
Teachpendant	Safety Event: Enter safety mode by tristate switch, cannot run the project.	Prompt message	/	/
Teachpendant	Safety Event: Enter safety mode by external safety IO, cannot run the project.	Prompt message	/	/
Teachpendant	Safety Event: Enter safety mode by linked IO, cannot run the project.	Prompt message	/	/
Teachpendant	Safety Event: Enter collision, cannot run the project.	Prompt message	/	/
Robot Controller	Power On Failed	Prompt message	/	Contact after sales
Robot Controller	Release brake failed	Prompt message	/	Contact after sales
Robot Controller	Forbid power-on robot in safeguard stop mode	Prompt message	/	Release safety shutdown related signals
Robot Controller	Robot shutdown in progress	Prompt message	/	/
Teachpendant	Stop Program refused, because program is stopping	Prompt message	/	/

Type	Information	Description	Possible error	Solution
Teachpendant	Stop Program refused, because program stopped	Prompt message	/	/
Teachpendant	Execute Command failed because some command is executing	Prompt message	/	/
Teachpendant	Execute Command failed because command was executed	Prompt message	/	/
Teachpendant	Loading language	Prompt message	/	/
Teachpendant	Load language finished	Prompt message	/	/
Robot Controller	Please wait for robot to stop	Prompt message	/	/
Robot Controller	Over speed protect	Prompt message	The arm is powered off	All clear Drag to reduce speed
Robot Controller	Singularity warning caused by ik failure	Prompt message	/	All clear
Robot Controller	Online track planning failed	Online track planning failed	Irregular move	Replanning the track
Robot Controller	Offline track planning failed	Offline track planning failed	Irregular move	Replanning the track

Type	Information	Description	Possible error	Solution
Robot Controller	Robot status exception	Abnormal status, unable to move	Abnormal status, unable to move	Replanning the track Make sure that various alarms have been cleared, and judge whether the teach pendant is mixed with the SDK
Robot Controller	Track Play Interrupt Track record cannot be paused and stopped	Prompt message	/	/
Teachpendant	Run to ready point error Make sure the project is loaded and then run to the ready position	Prompt message	/	/
Teachpendant	Run to ready point error: Make sure the project is stopped and then run to the ready position	Prompt message	/	/
Teachpendant	Running Project Error: Make sure the project is stopped before run project	Prompt message	/	/
Teachpendant	Running Project Error: Enter the safety mode, unable to run project.	Prompt message	/	/
Teachpendant	Pause Project Error: Make sure the project is running before pause project	Prompt message	/	/

Type	Information	Description	Possible error	Solution
Teachpendant	Continue Project Error: Make sure the project is paused before continue project	Prompt message	/	/
Teachpendant	Slowly Stop Project Error: Make sure the project is running before stop project	Prompt message	/	/
Teachpendant	Load Program Error: Make sure the program is stopped before load program	Prompt message	/	/
Teachpendant	SDK Interface blocked, need to restart	Prompt message	/	Copy the log and contact after sales
Interfaceboard	Safety IO Event: Run to ready position	Prompt message	/	/
Interfaceboard	Safety IO Event: Run program	Prompt message	/	/
Interfaceboard	Safety IO Event: Pause program	Prompt message	/	/
Interfaceboard	Safety IO Event: Continue program	Prompt message	/	/

Type	Information	Description	Possible error	Solution
Interfaceboard	Safety IO Event: Slowly stop program	Prompt message	/	/
Interfaceboard	Safety IO Event: Enter reduced mode	Prompt message	/	/
Interfaceboard	Safety IO Event: Release reduced mode	Prompt message	/	/
Interfaceboard	Safety IO Event: Enter the safety mode by external safety stop DI	Prompt message	/	/
Interfaceboard	Safety IO Event: Enter the safety mode by tri state switch	Prompt message	/	/
Interfaceboard	Safety IO Event: Enter the safety mode, please manually release the external safety stop DI	Prompt message	/	/
Interfaceboard	Safety IO Event: Manually release safety mode	Prompt message	/	/
Interfaceboard	Safety IO Event: Automatically release safety mode	Prompt message	/	/
Interfaceboard	Safety IO Event: Remote clear alarm signal	Prompt message	/	/

Type	Information	Description	Possible error	Solution
Interfaceboard	Safety IO Event: start run to ready position	Prompt message	/	/
Interfaceboard	Safety IO Event: stop run to ready position	Prompt message	/	/
Interfaceboard	Error throw: Joint encoder pollution	Prompt message	/	/
Interfaceboard	Error throw: Joint collision	Prompt message	/	/
Interfaceboard	Error throw: Hardware error	Hardware malfunction	/	Contact after sales
Interfaceboard	Error throw: Joint error	Hardware malfunction	/	Contact after sales
Interfaceboard	Error throw: Joint overcurrent	Hardware malfunction	/	Contact after sales
Interfaceboard	Error event: Joint overvoltage	Hardware malfunction	/	Contact after sales
Interfaceboard	Error throw: Joint undervoltage	Hardware malfunction	/	Contact after sales
Interfaceboard	Error throw: Joint over temperature	Hardware malfunction	/	Contact after sales
Interfaceboard	Error throw: Joint hall error	Hardware malfunction	/	Contact after sales
Interfaceboard	Error throw: Joint encoder error	Hardware malfunction	/	Contact after sales
Interfaceboard	Error throw: Joint absolute encoder error	Hardware malfunction	/	Contact after sales

Type	Information	Description	Possible error	Solution
Interfaceboard	Error throw: Joint current detect error	Hardware malfunction	/	Contact after sales
Interfaceboard	Error throw: Joint encoder z-signal error	Hardware malfunction	/	Contact after sales
Interfaceboard	Error throw: Joint encoder calibration failed	Hardware malfunction	/	Contact after sales
Interfaceboard	Error throw: Joint IMU sensor invalid	Hardware malfunction	/	Contact after sales
Interfaceboard	Error throw: Joint temperature sensor error	Hardware malfunction	/	Contact after sales
Interfaceboard	Error throw: Joint canbus error	Hardware malfunction	/	Contact after sales
Interfaceboard	Error throw: Joint current error	Hardware malfunction	/	Contact after sales
Interfaceboard	Error throw: Joint current position error	Hardware malfunction	/	Contact after sales
Interfaceboard	Error throw: Joint over speed	Prompt message	/	Copy the log and contact after sales
Interfaceboard	Error throw: Joint over accelerate	Prompt message	/	Copy the log and contact after sales
Interfaceboard	Error throw: Joint tracking accuracy error	Prompt message	/	Copy the log and contact after sales
Interfaceboard	Error throw: Joint target position out of range	Prompt message	/	Copy the log and contact after sales
Interfaceboard	Error throw: Joint target speed out of range	Prompt message	/	Copy the log and contact after sales
Interfaceboard	Error throw: Robot type error	Prompt message	/	Contact after sales

Type	Information	Description	Possible error	Solution
Interfaceboard	Error throw: Acceleration sensor error	Hardware malfunction	/	Contact after sales
Interfaceboard	Error throw: Encoder line error	Hardware malfunction	/	Contact after sales
Interfaceboard	Error throw: Enter force control error	Prompt message	/	Contact after sales
Interfaceboard	Error throw: Exit force control error	Prompt message	/	Contact after sales
Interfaceboard	Error throw: Driver version error	Hardware malfunction	/	Contact after sales
Interfaceboard	Error throw: Protection stop timeout	Prompt message	/	Contact after sales
Interfaceboard	Error throw: Reduced mode timeout	Prompt message	/	Contact after sales
Interfaceboard	Error throw: Unknown robot event from interfaceboard System abnormal	Prompt message	/	Contact after sales
Interfaceboard	Error throw: Mcu communication error	Prompt message	/	Contact after sales
Interfaceboard	Error throw: Tool RS485 communication error	Hardware malfunction	/	Contact after sales
Robot Controller	IK failure, Robot enters ambiguous space	Prompt message	/	Replanning the track
/	exception that joint	exception that joint	Unable to control the robot	Click Settings - Robot - Safety - Joint limit - Joint limit Enabled-Save to reset.



AUBO (Beijing)Robotics Technology Co.,Ltd.

Add: The 3rd Floor, Sunshine Buliding,China
102300 (Headquarters)

Tel : +86 010-88595859 / 60864660

Email: info@aubo-robotics.cn

Web: www.aubo-robotics.cn

AUBO (Jiangsu)Robotics Co.,Ltd.

Add: The 3rd Floor, B Blotk Of Zhongke
Business Center, Changzhou Science and
Education Town, Changzhou, Jiangsu, China

Tel: +86 0519-86339960

